

THORN

Exclusive Distributor

stealth
VENTURES

tel no: 02 8260 8023
mobile: 0919 088 4366
email: info@stealthventures.com.ph
web: www.stealthventures.com.ph

LED Lighting



Outdoor or indoor, urban or rural, LED technology offers the ultimate solution. No other light source allows you to improve optical performance while reducing energy consumption and maintenance.

Performance, Efficiency, Comfort

LEDs are the essence of good lighting design, offering Performance, Efficiency and Comfort.

Performance

High light Output Ratio

The nature of compact fluorescent downlights means significant amounts of light never leave the luminaire and as a result, light output ratios (LOR) as low as 40 to 80 percent are common.

LEDs however maximise the directional nature of the light source, enabling a LOR as high as 100 percent to be achieved.

Enhanced colour rendering

Improvements in colour rendering and colour stability have added to the exceptional performance of LEDs. Base LED and Quattro LED for example feature better phosphor and more even phosphor coating as well as amber LED to balance the colour temperature through life. It is now possible to light a task with a better ability to judge colour and reveal detail with more consistent colour across the full beam angle.

Easier maintenance

The increasing availability of replacement LED modules, such as that used in Chalice LED, mean that the whole luminaire does not need to be replaced when the LED reaches its rated life. This makes maintenance easier and cheaper, as well as more sustainable.

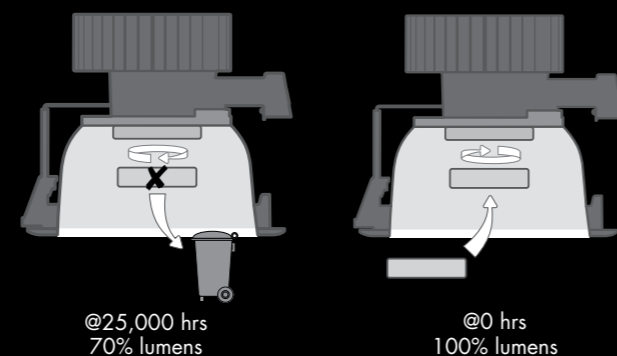
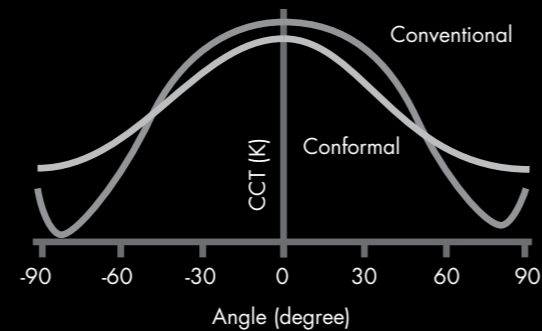
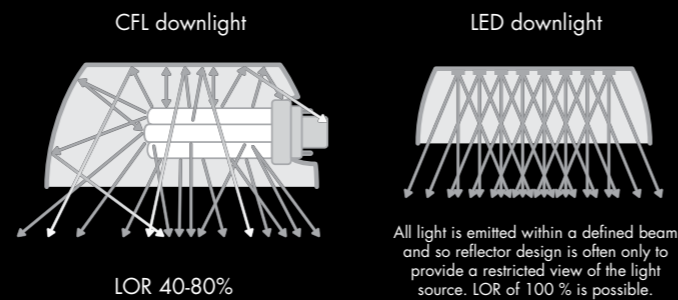

Why LED Lighting?

- High optical performance
- Compact light source with precise beam control
- Instant and full light output
- Low wattage for energy savings
- Long operating life (>50,000 hours)
- Reduced maintenance now with light source replacement
- No UV or IR radiation
- Zero mercury
- Choice of colours and colour temperatures
- Dynamic colour change
- 0 - 100% dimming (which also improves LED lifetime further)

Why Thorn LED Lighting?

As a trusted global supplier of professional outdoor and indoor lighting with integrated controls, we have years of experience in luminaire development and an extensive LED range.

Leveraging Zumtobel Group's research and development facilities, we actively work to raise lighting standards and are uniquely placed to combine the latest light source technology with our specialist expertise in optical and luminaire design.

Whether you're lighting roads, the cityscape, or buildings and surroundings, with our products you can achieve a solution where aesthetics, optical performance, energy consumption and maintenance are all in perfect balance.

Efficiency

Greater energy control

Accounting for around 19 percent of total world energy use, lighting is a major source of energy consumption but also offers a significant opportunity to reduce energy usage. LED technology combined with dimming and lighting controls however provide increased efficiency and less energy consumption, providing the right amount of light and only where and when it is needed.

LEDs are renowned for high optical performance with low energy consumption. Replacing old fluorescent Chalice luminaires for example with Chalice LED could reduce energy consumption by 50 percent while maintaining light quality.

Similarly, replacing a tungsten halogen downlight with a Lightstream 2 luminaire could reduce energy consumption by 86 percent while maintaining light quality.

Long life

Good thermal design also means many LEDs have a 50,000-hour expected lifetime, which for some lamps can extend to 120,000-hours in the right environment with dimming. A longer life means less maintenance and of course, lower costs.

Comfort

Lighting to suit

New phosphor-based LED luminaires such as Chalice and Base LED offer softer, low glare lighting for enhanced comfort. LED luminaires such as D-CO LED and Lightstream 2 however also enable you to add sparkle, creating a completely different environment.

No flicker

All our LED products are supplied with electronic drivers. These eliminate flicker and improve user comfort by reducing annoyance and headaches.

Choice of colour temperatures

We offer most LED solutions in a range of colour temperatures, so you can ensure comfort while matching the ambience created by other light sources in the application.

Course of overall costs of solution over lifetime

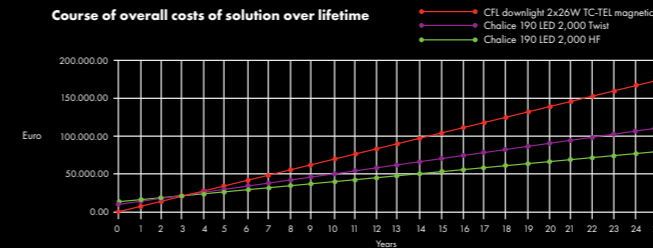

Comparison based on 2x26w CFL Chalice and 1x32W Chalice LED, in an office of 6 luminaires, running 11 hours per day, 5 days per week, 52 weeks per year. CFL Chalice at 57W consumes 978kWh/yr, new Chalice LED consumes 549kWh/yr, saving 492kWh/yr - the equivalent of 206kg CO2/yr.



Contents

ROAD



StylLED
p9



Oxane
p10



Indra
p10

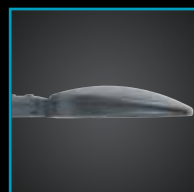

Dyana LED
p13



Clan LED
p14

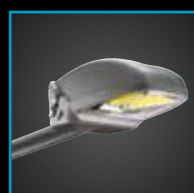

Atla LED
p17



Christian IV LED
p19



**Victor/
Victoria LED**
p19

CITYSCAPE



Plurio LED
p23



Adelie
p25



Nella LED
p25

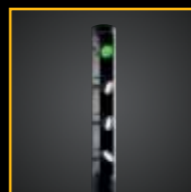

Alumet Stage LED
p26

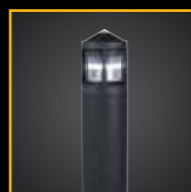

Promenade LED
p26



Avenue F LED
p29

BUILDINGS AND SURROUNDS



E/Fact Slim LED
p35



E/Fact LED
p35



Mica Slim LED
p35

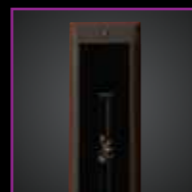

Band
p36



Cesar LED
p36



Contrast LED
p38



Qba LED
p38



D-CO LED
p40

BUILDINGS AND SURROUNDS



Contrast Mini Pinspot LED
p42



Milo
p42

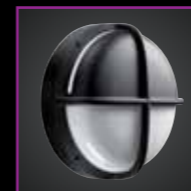

EyeKon LED
p45



Leopard
p45



Menlo³ Circular
p46



Quattro LED
p49



Chalice 190 LED
p50



Cruz 160 LED
p50

BUILDINGS AND SURROUNDS



**Base LED/
Base LED Junior**
p53

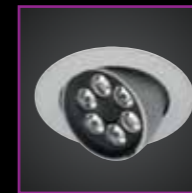

D-CO LED
p54



Lightstream 2
p54



Prospector LED
p56



Tidon LED
p56



Glacier II LED
p58

EMERGENCY

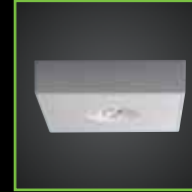

Voyager LED Series
p61



Voyager Sigma
p61

Road Lighting - Best Practice

Road lighting

Aside from helping users see, road lighting is essential for reducing the dangers that could develop from poor visibility. Whether you're lighting a busy junction or a quiet street, LEDs offer new opportunities for an intelligent, efficient and effective solution.

Using precise optical design, simple dimming and adaptable photometric outputs for variable weather conditions, users can enjoy better light and visibility while local authorities can reap fast and low risk financial returns.

With luminaires such as Oxane and Indra now offering a payback in less than five years, you can find a road lighting solution that ticks all the boxes.

Precise optical Control

Modern road lanterns use a small number of high power LED to light the road surface. Though the risk is small if you lose one LED there is a chance of a dark spot on the road. At Thorn we design for this, with patented reflector design to ensure dark spots never happen.

Simple and effective dimming

With LEDs, energy use is reduced in roughly the same proportion as the dimming percentage. As an example if you take our electronic StepDim controls it can allow you to reduce energy consumption by a further 50 percent during off-peak hours while maintaining colour, performance and efficiency.

Over time, the additional savings generated by dimming LEDs will offset the higher capital cost, giving a viable alternative solution to conventional light sources. As energy costs rise, so will the savings. Reducing road lighting levels also has environmental benefits in curbing carbon emissions and further reducing obtrusive light.

Please note other outdoor lighting controls such as Telea are available throughout our Road lighting ranges.

Course of overall costs of solution over lifetime

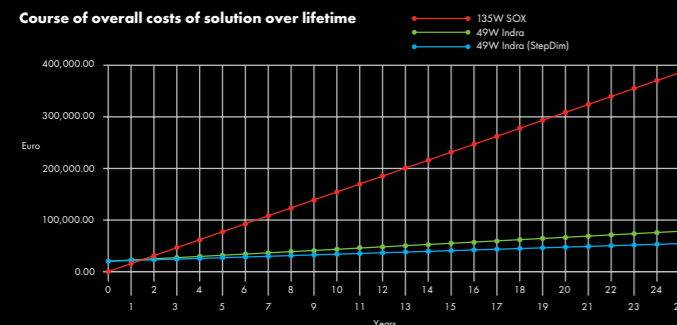

Nya Gärdarna, Landskrona, Sweden



Polkowice ul. młyńska, Poland

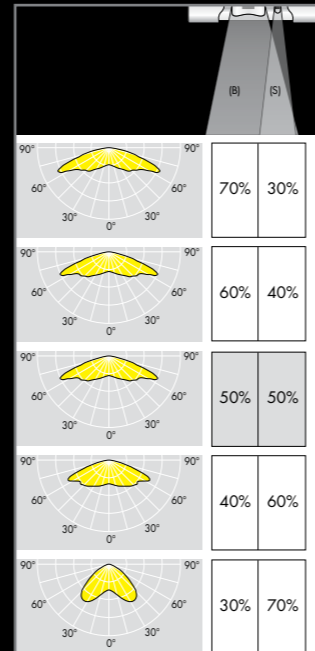

Adaptable photometric outputs

To accommodate variable weather conditions, our StyLED road lantern features the EQflux® system. The intelligent electronic driver offers 15 pre-set light distributions by dynamically reconfiguring the LEDs. The standard pre-set settings of 50-50 is suitable for most applications. Crucially, we build every lantern according to the project's requirements to satisfy all fixed constraints.

Case Study: StyLED lanterns light Orly Airport modernisation

Following a successful pre-launch presentation to the top management of Aéroport De Paris (ADP), StyLED luminaires were installed at Orly Airport.

The French airport was undergoing extensive modernisation work with sustainability and energy saving a top priority. As part of the renovation, the access road to the "Pavillon d'Honneur" was changed from a bilateral installation with 150W HPS lamps every 20m to a unilateral installation with StyLED 103W (7700 lm) every 20m. The result is a 25 percent power reduction for six hours at night.

"We wanted a solution that was simultaneously aesthetically pleasing, contemporary and energy-saving. We selected StyLED, which was one of the latest innovations Thorn showed us at the last Frankfurt Show. The result is excellent on all levels. In terms of design, StyLED fits in with our commitment to give an important road a more modern image. And it's a truly cost-saving solution too. Above all, we halved the number of light points by locating them on one side only. We also save on maintenance as the LEDs have a longer life. In terms of efficiency, there are no areas of shadow and the lighting is truly uniform."

Finally, by choosing 7-metre fibreglass masts, we have completely accommodated the airport's constraints by avoiding the electromagnetic fields close to the runways. There now remains only one more step to achieve the perfect outcome: the centralised technical management (CTM) coverage of all our lighting equipment."

Stéphane Gay
Assistant Maintenance Manager for ADP, Orly





Orly Airport, France

StyLED



Lamps

LED 39-129W 3000-13000lm
up-to 75.32 luminaire Lm/W

Standards



www.thornlighting.com/STYL

Ideal for major and minor roads, StyLED has an EQFlux® system that offers 15 pre-set light distributions built from three optics.





Oxane



Lamps

LED 28-84W LED 2000-6600lm
up-to 75.83 luminaire Lm/W

Standards



T_a -25
+35

www.thornlighting.com/OXAN

Available in four configurations covering lighting classes up to ME3, Oxane offers stand alone dimming, minicell and remote monitoring capabilities. Fully maintainable for longevity.

Indra



Lamps

LED 49-98W LED 3000-7800lm
up-to 79.51 luminaire Lm/W

Standards



T_a -25
+35

www.thornlighting.com/INDR

Indra is designed for use with high efficiency LEDs and has a protected heat sink and optic. Optimised heat dissipation extends lifetime.



Polkowice ul. mły ska, Poland



Sully sur Loire, Orleans, France

Dyana LED

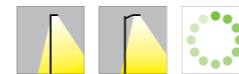

Lamps

LED 2828Lm (39W)/4242Lm (58W)
up-to 73 luminaire Lm/W

Standards



www.thornlighting.com/DYNL

Dyana is an aluminium lantern available in two outputs and a choice of two optics for S6 to S2 classifications. Variable spigot assembly for either post-top or side entry mounting.





Clan LED



Lamps
 LED 2828lm (39W)/4242lm (58W)
 up-to 75 luminaire lm/W

Standards
 CE EN 60598 IP66 IK08 T_a-20/+35

www.thornlighting.com/CLAN

Ideal for cityscape rejuvenation, Clan offers two lantern designs, three bracket collections, two optics, 15 lamps and control options.



Toulouse, France



Göteborg, Sweden

Atla LED



Lamps

LED 1800lm (24W) / 3000lm (42W)
up-to 64.88 luminaire lm/W

Standards

CE EN 60598-2-3 EN 13201 IP65 IK08 T_a 0/+25

www.thornlighting.com/ATLL

Combining a powerful and efficient optic, Alta offers a choice of enclosures and is engineered for low maintenance. Its comfortable colour temperature makes it the perfect choice for residential and minor roads.





Nya Gärdarna, Landskrona, Sweden

Christian IV LED

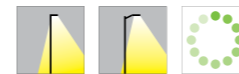

Lamps

LED 1800Lm (24W) / 3000Lm (42W)
up-to 72 luminaire Lm/W

Standards



www.thornlighting.com/CHIV

Simple and elegant design from Christian Hvidt. New asymmetric optic provides excellent lighting performance with no upward light or light trespass and good glare control.

Victor/Victoria LED



Lamps

LED 1800Lm (24W) / 3000Lm (42W)
up-to 75 luminaire Lm/W

Standards

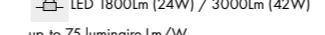

www.thornlighting.com/VICT
www.thornlighting.com/VICA

Designed for fast maintenance and installation, Victor/Victoria has a 'twist and lock' hinge for easy access to components. Choice of fixings for post top or side entry mounting.



Cityscape - Best Practice

Cityscape

Lighting the cityscape blends two lighting demands: the need to see and the aesthetics of the city itself. As people wander the public spaces in our towns and cities they need to navigate, interact with others, feel safe and remain visible. Add to that the need to be ever more efficient, while being more design conscious, and it's clear the cityscape designer needs to think hard. Offering a comprehensive solution, our cityscape LED products are specifically designed to harmonise optical performance, installer functionality and beautiful night time aesthetic.

Lighting where you want it, how you want it

Enhanced optical designs mean many of our luminaires enable you to put light just where you need it, efficiently and with reduced glare. Avenue F's prismatic optical crown and Adelle's indirect light are great examples.

Luminaire and maintenance efficiency

50,000-hour lifetimes are common but depending on ambient temperature and dimming, Thorn's cityscape range can extend to 120,000 hours.

As for gear life, most Thorn LED luminaires now have replaceable components, making routine maintenance easier, quicker and cheaper. Many also have control options to make it possible to reduce energy consumption by up to a further 50 percent while maintaining colour performance and efficiency.

Balancing the public and traffic mix

For areas where public and traffic mix, luminaires such as Clan (featured under road lighting) and Plurio offer the optical and energy performance required for both. With optical choice and a family of simple, modern aesthetics, applying the right light source to the task is easy.



Spennymoor, UK



St. Heddinge, Denmark



La Ronde Couture Charleville Maziere, France

Case Study: Adelle reduces energy consumption by 91 per cent

Named after a small cross that used to be on the nearby beach, the Boulevard de la Croisette in Cannes consists of a 2km historic stretch of sand and palm trees along the French Riviera. Thorn won a competitive tender to put this beautiful city in a new light while retaining its character.

Adelle LED lanterns were selected to achieve the desired soft, indirect white light while also delivering considerable maintenance and energy savings. The initial 30 lanterns have reduced energy consumption by 91 percent and as a result of the project's success, a further 170 lanterns will be installed over the next two years.



Bijou Plage, Cannes

Dyana and Plurio revitalise Bethoncourt

As part of an extensive urban renewal programme, Bethoncourt in France has a new street lighting scheme to improve travel conditions and upgrade the main axis of the neighbourhood, making it a more attractive place to live, work and visit.

The new scheme includes 30 stylish Dyana street lanterns and 26 Plurio decorative lanterns. Offering excellent colour appearance (4200K) and rendering, the patented high performance optics eliminate light above the horizontal and meet the town's need for a more pleasant environment. At the same time, the luminaires offer all the benefits of energy efficiency and reliability associated with LEDs.

Overall, Bethoncourt demonstrates how the latest lighting equipment uses less energy while enhancing task performance and improving both the nighttime atmosphere and daytime appearance.



Bethoncourt, France



Plurio Round, Hammarparken, Kristianstad, Sweden

Plurio LED



Lamps

LED 1500 lm luminaire output/20W, 2000lm/ 30W, 2400lm/40W
 colour temperature: neutral white 4100K, CRI: 65, intelligent overheating protection
 up-to 76 luminaire Lm/W

Standards

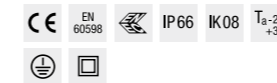

www.thornlighting.com/PLRL

Ideal for renovating urban and residential areas, Plurio offers up to 86% energy savings versus former solutions. Unobtrusive light preserves the nightscape.



Bethoncourt, France





Copenhagen, Denmark

Adelle



Lamps

LED 32W
up-to 33 luminaire Lm/W

Standards

CE EN 60598 EN40 IP65 IK08

www.thornlighting.com/ADLE

Elegant design offering indirect light. Adelle's canopy, reflector and optics are all designed for visual comfort. Robust aluminium construction is easy to install and maintain.

Nella LED

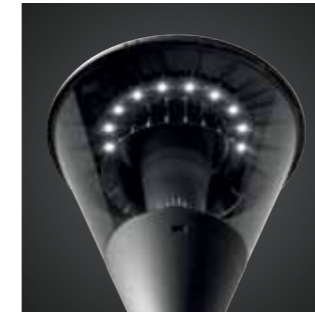

Lamps

LED 37W
up-to 58 luminaire Lm/W

Standards

CE IP66 IK08

www.thornlighting.com/NLLL

Aesthetically appealing, Nella minimises obtrusive light. A practical solution offering excellent light distribution, durability and ease of maintenance suitable for residential refurbishments.









Alumet Stage LED



Lamps
 LED 4X17W
 up-to 47 luminaire Lm/W

Standards
      



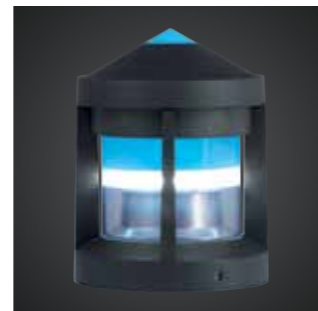

www.thornlighting.com/ALUS

Alumet Stage offers a range of effects thanks to four multidirectional spotlights and various optical accessories. Several colours available with intensive or semi-intensive beam.

Promenade LED



Lamps
 LED 24.5W
 up-to 27 luminaire Lm/W

Standards
    

www.thornlighting.com/PMLD

Stylish bollard and parapet directing light from 15 LEDs towards the ground. Removable accessory allows either the optic or the top cone to be lit in colour.



Adelaide Show Ground, Adelaide, Australia



La Ronde Couture Charleville Maziere, France



Badstuegade, Haderslev, Denmark



Avenue F LED

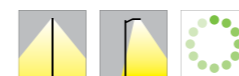
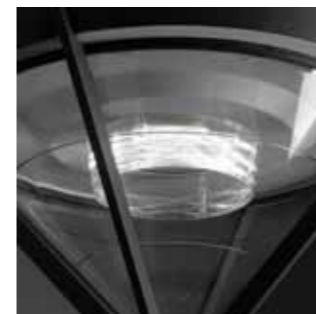

Lamps

LED : 1600lm/20W (luminaire output/power with driver), 2000lm/30W and 2600lm/40W, colour temperature: neutral white 4100K, CRI: 65, intelligent overheating protection
up-to 82 luminaire lm/W

Standards



www.thornlighting.com/AVFL

Part of a complete family, Avenue F is a post top lantern with prismatic crown for reduced glare and a unique light signature.

Buildings and Surrounds - Best Practice

Buildings and surrounds

By offering design advances as well as flexibility and efficiency, LEDs present the ideal solution for buildings and their surroundings.

Effortlessly complementary

Whether you need to enhance a building's design through dramatic lighting or subtly complement beautiful architecture, LEDs create endless possibilities. Crucially, their small size gives you unrivalled flexibility for great lighting effects.

Linear luminaires such as Band for example can be close offset to reveal texture and shape, while spotlights such as D-CO LED and Milo allow complete accuracy and in doing so, reduce nuisance light.

On the other hand, where the distance is greater, powerful floodlights with a range of optical attachments, such as Contrast LED allow you to pick out detail from a significant distance using a fraction of the power of a metal halide source.



La Chassagne, France



Mt. Barker, Australia



Park Polanica, Poland

Within the building LED is making significant contributions to energy reduction and lighting quality in many applications. In Offices, Education, Healthcare, Hotel and Retail the use of LED light sources in downlights has resulted in significant savings when compared to traditional compact fluorescent and tungsten based lighting. This is particularly the case in circulation spaces such as corridors and stairwells.

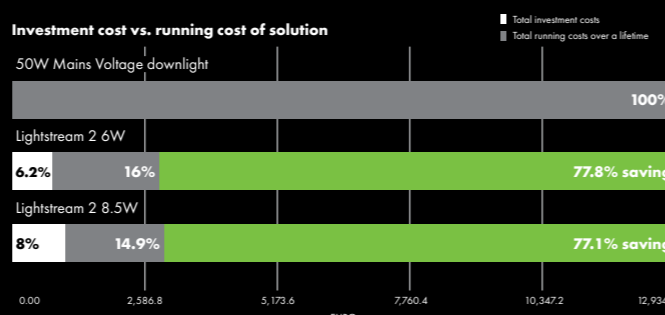
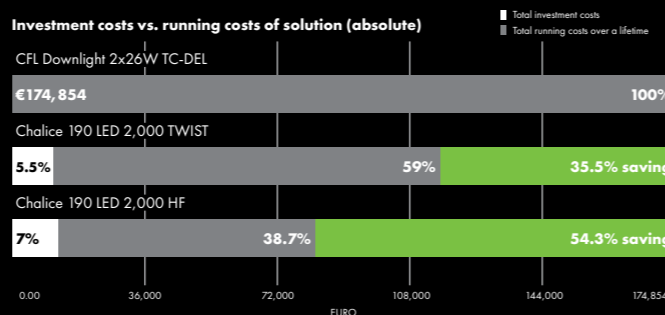

The advantage of LED in precise optical design and its directional nature make the choice easy here. But the same is becoming reality in recessed luminaires. Greater efficacy can be achieved in Menlo³ LED and Quattro LED than ever before and these luminaires now offer a sensible alternative for some open spaces, especially when combined with good lighting controls.

For other spaces, often frequented, but for short periods, the use of bulkheads such as Leopard LED with its inbuilt presence sensor reaps the rewards of significantly longer light source life - LED simply does not suffer reduction in life from frequent switching like other sources do.

	Leopard LED	Leopard 1x28W HF
Light source	LED	28W GE Wattmiser
Colour temperature	4000k	4000k
Luminaire lumens	1250	1350
Luminaire lm/W	>60	54
System power	20.5w	25w
Expected life time	50,000 hrs	15,000 hrs
Switching time	Instant	Warm up
Presence sensor option	Yes	Yes
Emergency option	Yes	Yes
Maintenance	Minimal	Lamp replacement every 15,000 hrs

Through to Industry and large open spaces can now be lit with LED, offering uniform lighting with minimal glare and long maintenance cycles suitable for buildings that are often difficult to access. Combined with controls for presence and daylight this luminaire can offer significant energy reductions through life.



Netherburn Primary School, Scotland

On finally to retail and display areas and our range of spotlights now include indirect LED sources, Prospector LED, D-CO LED and Tidon LED offering enhance colour, energy reduction and reduced glare whilst maintaining a good optical choice to pick out goods and artefacts in cool, UV free light with good colour rendering. Suspended decorative luminaires such as Glacier LED add to the ambience by contributing to the vertical light in the room and helping to pick out reception or sales desks, where low glare light to the face is so important.

In emergency Lighting LED is set to change luminaires beyond belief. So much smaller with perfectly tuned optics, luminaires such as Voyager LED Route and Area can provide improved spacing that significantly reduces the number of emergency luminaires to light the space at the time of greatest need. This means lower install cost, and the longer light source life, reduced battery strain and size, the easy of replacement and test will also significantly reduce through life cost and environmental impact. Add to this Voyager Task and we can now light with minimal intrusion those areas of high risk or extra emphasis that all buildings have. Such LED emergency solutions can also be found in other luminaires such as Menlo³ and PopPack, opening new technologies for safety to all applications.



Case Study: Oldest football stadium gets the latest LED treatment

Newcastle United's St James' Park, the oldest football stadium in North East England, has received the latest LED treatment. Aside from the need to improve energy efficiency and light quality, lighting maintenance at the club was a major cost and burden with large numbers of lamp replacements required before every match. Significantly, with the average life of the LED downlights 24 times that of tungsten halogens, the re-provision would give each downlight an additional lifetime equivalent of 3,571 match days, creating irresistible financial savings.

The new lighting scheme covered the executive boxes, corridors and emergency lighting.

Executive boxes

Lighting in the executive boxes comprised of CFL downlights and power hungry dichroics. We however installed a mixture of 19 high efficiency spotlights and downlights, including Base LED and D-CO LED, to dramatically reduce the electrical loading from 400W to 275W while delivering an attractive high quality white light.

To solve the problem of providing guests with as much or as little light as they desire, as well as reducing running cost at the same time, a straightforward Sensalink lighting control system was also installed. Occupants are now able to adjust the room lighting via a simple scene plate while presence sensors further reduce electricity consumption.

The combination of efficiency and occupant control means the installation reduces electricity costs for the boxes by approximately 30 percent.

Corridors

The football club also needed to improve the lighting along the fifth and sixth floor corridors, which was a much bigger task. Here was a typical example of an area that would benefit from a broader light distribution than that afforded by the existing 273 mainly twin lamped CFL and dichroic downlights.

Thorn's solution therefore included 151 Quattro LEDs providing a high level of soft, low brightness illumination. As well as improving the CRI from 80 to 92, the electrical load was virtually halved from 14.1 to 7.4kW, which not only cuts energy costs by around 50 per cent, but will also save approximately £4,000 per annum in future carbon taxation costs. What's more, the 50,000-hour lifetime will further add to the financial savings by reducing maintenance costs.

Emergency lighting

Should the power fail, both the executive boxes and corridors have been fitted out with Voyager LED luminaires to help occupants locate the most appropriate escape route. Not only are the sophisticated 2.7W LED emergency lights more aesthetically pleasing than traditional fluorescent systems, but they also consume less power, give better light control, require smaller integral power supplies and can be spaced more widely, creating additional savings in installation and running costs.





The Eden Project, UK



E/Fact Slim LED



Lamps

LED 1.2-19.2W



www.thornlighting.com/EFCT

Designed for guidance or illumination, E/Fact Slim has a shallow depth and is available with frosted and semi-frosted glass. Three sizes and two colour options. Square and round shapes. Choice of accessories to design the light beam.

E/Fact LED



Lamps

LED 1.2-14.4W

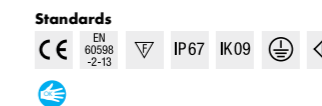

www.thornlighting.com/EFCT

Designed for guidance or illumination, E/Fact is available with a choice of colours, shapes and sizes, and with frosted or semi-frosted glass. Square and round shapes. Choice of accessories to design the light beam.

Mica Slim LED

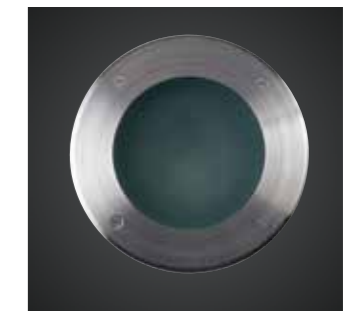

Lamps

LED 1.2-14.4W



www.thornlighting.com/MICA

Designed for guidance or illumination, Mica Slim is shallow and available in four sizes and two colours. Aluminium or stainless steel frame. Round shape. Choice of accessories to design the beam.



Band



Lamps

LED 12W

Standards

CE EN 60598 IP67 IK08

www.thornlighting.com/BAND

Band has an innovative optical reflector to give high output and uniformity with no flame effect when lighting facades. Slim style with a choice of colours and optional RGB colour change technology.

Cesar



Lamps

LED 1.2-2.4W

Standards

CE EN 60598 IP65 IK08

www.thornlighting.com/CESA

A wall mounted cylindrical floodlight with a choice of downward or up/down illumination. Cesar size 1 is available with whites (6000K and 3200K) and various colour options.



Mt. Barker, Australia





Contrast LED



Contrast LED RGB version



Lamps

LED 44W-65W

Standards

CE EN 60598 IP65 IK08 T_a25

www.thornlighting.com/CONL

Intensive dynamic or static LED technology with a choice of five monochromatic colours and dynamic RGB. Attachments offer a variety of beam distributions.

Qba LED



Qba LED RGB version

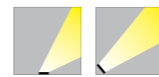

Lamps

LED 22W-36W

Standards

CE EN 60598 IP66 IK08 T_a25

www.thornlighting.com/QBLD

Qba LED is an architectural floodlight with 18 LEDs available in a range of colours and colour temperatures, as well as a dynamic RGB colour mixing with 8 multichips.



Napier Bridge, India

D-CO LED



Lamps

LED 1.2-7.2W

Standards

EN 60598 IP67 IK08 T_a25 Floodlights

EN 60598-2-13 IP67 IP68 IK09 Recessed

IK10 T_a25

www.thornlighting.com/DCOF
www.thornlighting.com/DCOR

D-CO LED compact floodlights are supplied with stirrup and ground spike for installation. Integral power supplies and visor to prevent obtrusive light. D-CO LED recessed in 3 sizes for guidance and illumination with round stainless steel frame.

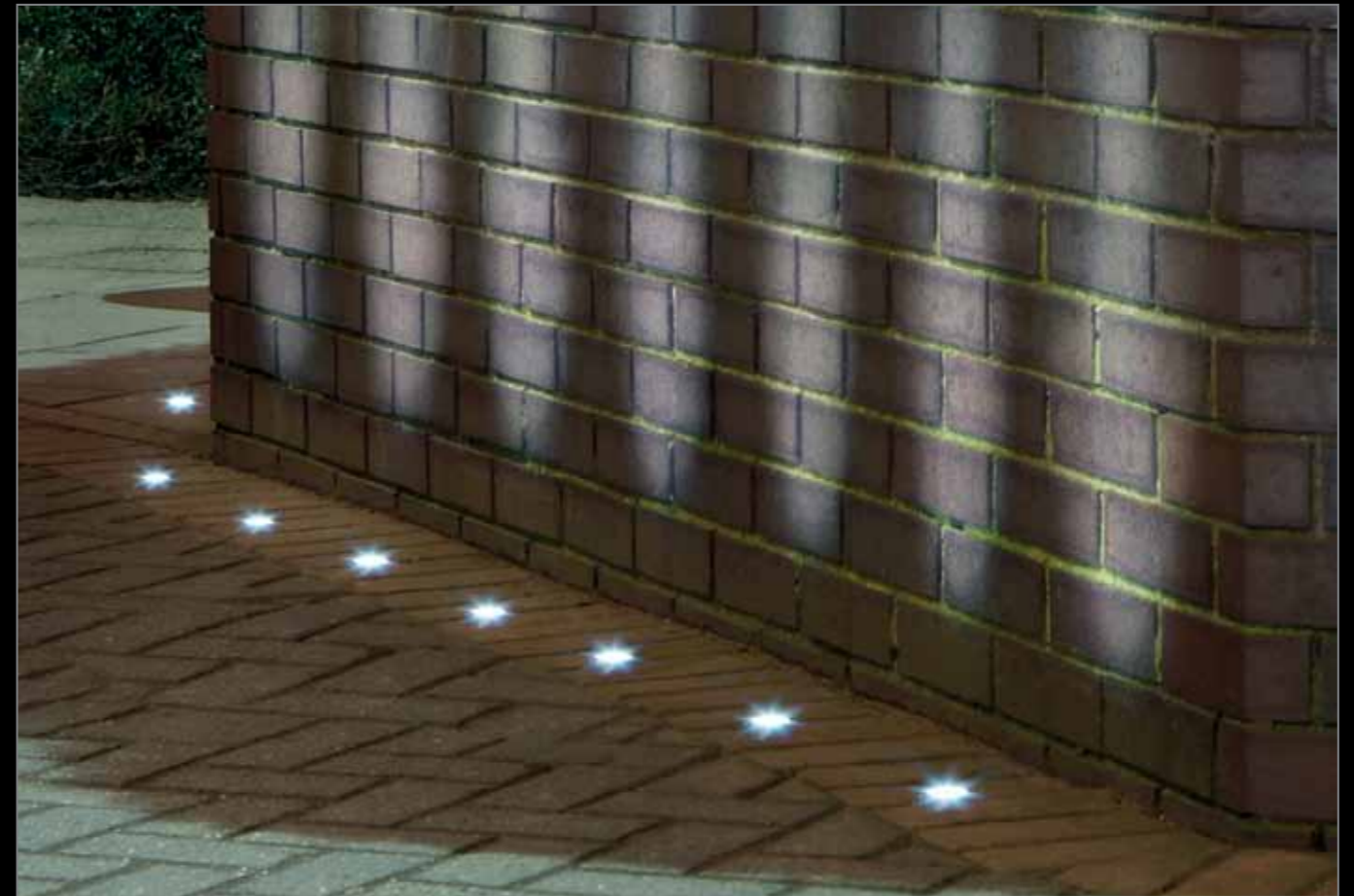

**Contrast Mini
Pinspot LED**



Lamps

LED 3.6W

Standards

CE EN 60598 IP65 IK08 T_a25 850°C



www.thornlighting.com/CONM

Small LED floodlight with choice of LED colours and white colour temperatures (6000K and 3200K). Choice of accessories to design the light beam.



Milo



Lamps

LED 2.4W

Standards

CE EN 60598 IP65 IK09



www.thornlighting.com/MILO

Adaptative floodlight with remote or integral gear for accentuation application.



Leeds Metropolitan University, UK



Helsingborg, Sweden

EyeKon LED

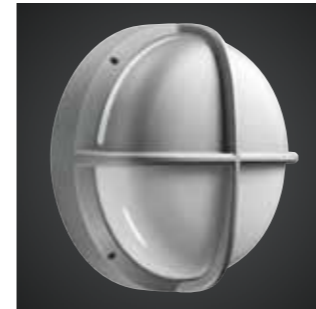

Lamps

LED 19W
20.3 luminaire Lm/W

Standards

CE EN 60598 IP65 IK10 T_a 0 +25 T_a-15 +35
850°C 960°C

www.thornlighting.com/EYKN

EyeKon is designed to spread light sideways, allowing wider spacing without leaving dark areas. Emergency and/or daylight options available.

Leopard LED



Lamps

LED 1W
>60 luminaire Lm/W

Standards

CE EN 60598 IP66 IK10 T_a 0 +25 850°C

www.thornlighting.com/LPRD

Suitable for indoor and outdoor applications with instant light and energy savings using the presence sensor option and emergency version available



Menlo³ Circular

Lamps

LED 3200lm
57 luminaire lm/W (Acrylic)

Standards

CE EN 60598 IP20 T_a25 T_a+25
850 °C

www.thornlighting.com/MNLC

Menlo³ Circular features a spherical central diffuser and surrounding light chamber for a visually appealing circular geometry. Outstanding photometric performance.





Netherburn Primary School, Scotland



St. James Park Stadium, Newcastle, UK



Quattro LED



Lamps

LED 3200lm
67 luminaire lm/W

Standards

CE EN 60598 IP20 T_a25 650°C

www.thornlighting.com/QTRL

Quattro is a recessed luminaire designed for exposed grid ceilings. Approximate 16-year life in a typical office environment. Opal diffuser or MPT optic.

Chalice 190 LED



Lamps

LED 11-24W 1100/2000 lm
67/76 1100 luminaire lm/W (830/840)
64/68 2000 luminaire lm/W (830/840)

Standards

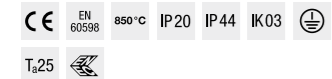

www.thornlighting.com/CHLD

Ideal for refurbishments, Chalice 190 offers low power consumption and a long life up to 50,000 hours. Reflector design with breakthrough texture coating improves vertical illumination.

Cruz 160 LED



Lamps

LED 11-29W 1100/2000 lm
1100 840: 79 luminaire lm/W
1100 830: 70 luminaire lm/W
2000 840: 65 luminaire lm/W
2000 830: 56 luminaire lm/W

Standards



www.thornlighting.com/CR16

Cruz 160 features the patented Thorn sec-loc® system to save time and money with rapid tool-free installation. Glare-free and highly-efficient, digital dimming as standard.



Haymarket Bus Station, Newcastle, UK



White Square Office, Moscow, Russia



Haymarket Bus Station, Newcastle, UK



Haymarket Bus Station, Newcastle, UK



Gabriel Marty University, Photographer: Patric Dumas



Haymarket Bus Station, Newcastle, UK

Base LED



Lamps

LED 12-18W
 650 927: 54 luminaire lm/W
 650 935: 54 luminaire lm/W
 1000 927: 56 luminaire lm/W
 1000 935: 56 luminaire lm/W

Standards



www.thornlighting.com/BASE

With Cree technology for unprecedented performance, Base LED offers stable light quality and excellent colour rendering. Good glare control and dimmable.

Base LED Junior



Lamps

LED 11.5W
 H: 52 luminaire lm/W
 L: 57 luminaire lm/W

Standards



www.thornlighting.com/BASJ

Offering a choice of two optics for performance and added comfort, Base LED Junior uses Cree technology for outstanding and stable colour rendition.





Lightstream 2 LED

D-CO LED



6 x 1.2W Downlight Multi-directional



Lamps

LED 1.2-3W
Average for the whole range: ~ 40 luminaire lm/W

Standards



www.thornlighting.com/DCOD
www.thornlighting.com/DCOW
www.thornlighting.com/DCSP

Perfect for adding some sparkle to an environment, D-CO LED is quick to fit, and maintenance free.

Available in warm or cool white colour options and consisting of eight products for a range of applications.

Lightstream 2



IP20 LED, white bezel, adjustable



Lamps

LED (PAR16) GU10 6-8.5W
8.5W - 400/430 luminaire lm/W (830/840)
6W - 300/350 luminaire lm/W (830/840)

Standards



www.thornlighting.com/LTSM

Fire rated, multi purpose downlight with a one year payback (vs 50W halogen), ideal for lighting homes and public buildings



D-CO LED 1.6W Asymmetric Wall Recessed



Helsingborg, Sweden



Prospector LED



Lamps

LED 12W
54 luminaire lm/W

Standards



www.thornlighting.com/PROL

Prospector creates a precise spot beam (19°) for effective accent lighting. Offers a real alternative to 75W halogen using a 5th of the energy! Warm appearance with excellent colour rendering.

Tidon LED



Lamps

LED 20W
830/840: 43.6 luminaire lm/W

Standards



www.thornlighting.com/TIDN

Tidon is adjustable to 30° from the vertical. Choice of spot or flood beam angles. Can be fixed without any tools into most suspended ceilings.

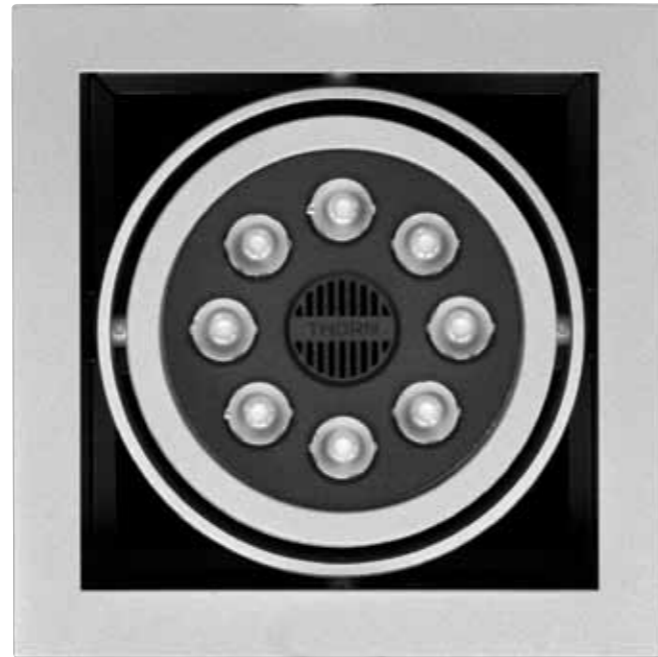

Hotel Puro, Poland



Dollan Aqua Centre, Scotland

Glacier II LED



Lamps

LED 20W
46lm/W/40lm/W

Standards

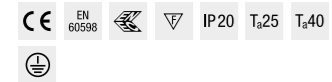

www.thornlighting.com/GLCR

As a small pendant, Glacier II is suitable for applications such as bars, restaurants, receptions, as well as retail environments.



Earl Mortimer College, UK



Earl Mortimer College, UK



Frederiksberg Radhus, Denmark



Netherburn Primary School, Scotland



Voyager LED Series



Voyager LED Spot, surface, silver



Lamps

LED Series E3TX 2.7W

Standards



www.thornlighting.com/VYLD

Self contained emergency luminaire with route, area and spot options. Available in white/silver, recessed/surface mounted. Can function as non-maintained, maintained or switched maintained. Three-hour duration.

Voyager Sigma



Lamps

LED 1W

Standards



www.thornlighting.com/VSIG

A self-contained single sided emergency exit sign. Arrow is available up, down, right and left. Can be updated if exit route direction changes. Three-hour duration.



Ordering Guides and Line Drawings

StyLED

Description	Wt (kg)	SAP Code
StyLED Short		
STYLED S 39W EXT55 CL1	12.90	96258215
STYLED S 39W EXT55 CL2	12.90	96258217
STYLED S 39W EXT55WB CL1	12.90	96258210
STYLED S 39W EXT55WB CL2	12.90	96258212
STYLED S 39W INT55 CL1	13.00	96258220
STYLED S 39W INT55 CL2	12.90	96258222
STYLED S 52W EXT55 CL1	13.20	96258200
STYLED S 52W EXT55 CL2	13.20	96258202
STYLED S 52W EXT55WB CL1	13.20	96258195
STYLED S 52W EXT55WB CL2	13.20	96258197
STYLED S 52W INT55 CL1	13.20	96258205
STYLED S 52W INT55 CL2	13.20	96258207
StyLED Short with Minicell		
STYLED S 39W EXT55 CL1 PM	13.00	96258216
STYLED S 39W EXT55WB CL1 PM	13.00	96258211
STYLED S 39W INT55 CL1 PM	12.90	96258221
STYLED S 52W EXT55 CL1 PM	13.30	96258201
STYLED S 52W EXT55WB CL1 PM	13.30	96258196
STYLED S 52W INT55 CL1 PM	13.30	96258206
StyLED Short with power reduction		
STYLED S 39W/BP10-50% EXT55 CL2	12.90	96258219
STYLED S 39W/BP10-50% EXT55WB CL2	12.90	96258214
STYLED S 39W/BP10-50% INT55 CL2	12.90	96258224
STYLED S 39W/BP6-25% EXT55 CL2	12.90	96258218
STYLED S 39W/BP6-25% EXT55WB CL2	12.90	96258213
STYLED S 39W/BP6-25% INT55 CL2	12.90	96258223
STYLED S 52W/BP10-50% EXT55 CL2	13.20	96258204
STYLED S 52W/BP10-50% EXT55WB CL2	13.20	96258199
STYLED S 52W/BP10-50% INT55 CL2	13.20	96258209
STYLED S 52W/BP6-25% EXT55 CL2	13.20	96258203
STYLED S 52W/BP6-25% EXT55WB CL2	13.20	96258198
STYLED S 52W/BP6-25% INT55 CL2	13.20	96258208
STYLED S 52W/BP8-34% EXT55 CL2	13.20	96259016
STYLED S 52W/BP8-34% EXT55WB CL2	13.20	96259015
STYLED S 52W/BP8-34% INT55 CL2	13.20	96259017
StyLED Short with Telea RF		
STYLED S 39W EXT55 LDRF CL1	13.00	96258722
STYLED S 39W EXT55 LDRF CL2	13.00	96258723
STYLED S 39W EXT55WB LDRF CL1	13.00	96258720
STYLED S 39W EXT55WB LDRF CL2	13.00	96258721
STYLED S 39W INT55 LDRF CL1	13.00	96258724
STYLED S 39W INT55 LDRF CL2	13.00	96258725
STYLED S 52W EXT55 LDRF CL1	13.30	96258716
STYLED S 52W EXT55 LDRF CL2	13.30	96258717
STYLED S 52W EXT55WB LDRF CL1	13.30	96258714
STYLED S 52W EXT55WB LDRF CL2	13.30	96258715
STYLED S 52W INT55 LDRF CL1	13.30	96258718
STYLED S 52W INT55 LDRF CL2	13.30	96258719

Description	Wt (kg)	SAP Code
StyLED Long		
STYLED L 103W EXT55 CL1	16.10	96258175
STYLED L 103W EXT55 CL2	16.10	96258177
STYLED L 103W EXT55WB CL1	16.20	96258171
STYLED L 103W EXT55WB CL2	16.20	96258173
STYLED L 103W INT55 CL1	16.10	96258179
STYLED L 103W INT55 CL2	16.10	96258181
STYLED L 129W EXT55 CL1	16.20	96258163
STYLED L 129W EXT55 CL2	16.20	96258165
STYLED L 129W EXT55WB CL1	16.30	96258159
STYLED L 129W EXT55WB CL2	16.30	96258161
STYLED L 129W INT55 CL1	16.20	96258167
STYLED L 129W INT55 CL2	16.20	96258169
STYLED L 77W EXT55 CL1	16.00	96258187
STYLED L 77W EXT55 CL2	16.00	96258189
STYLED L 77W EXT55WB CL1	16.00	96258183
STYLED L 77W EXT55WB CL2	16.00	96258185
STYLED L 77W INT55 CL1	16.00	96258191
STYLED L 77W INT55 CL2	16.00	96258193
StyLED Long with Minicell		
STYLED L 103W EXT55 CL1 PM	16.20	96258176
STYLED L 103W EXT55WB CL1 PM	16.20	96258172
STYLED L 103W INT55 CL1 PM	16.20	96258180
STYLED L 129W EXT55 CL1 PM	16.30	96258164
STYLED L 129W EXT55WB CL1 PM	16.30	96258160
STYLED L 129W INT55 CL1 PM	16.30	96258168
STYLED L 77W EXT55 CL1 PM	16.10	96258188
STYLED L 77W EXT55WB CL1 PM	16.10	96258184
STYLED L 77W INT55 CL1 PM	16.10	96258192
StyLED Long with power reduction		
STYLED L 103W/BP8-34% EXT55 CL2	16.10	96258178
STYLED L 103W/BP8-34% EXT55WB CL2	16.20	96258174
STYLED L 103W/BP8-34% INT55 CL2	16.10	96258182
STYLED L 129W/BP8-34% EXT55 CL2	16.20	96258166
STYLED L 129W/BP8-34% EXT55WB CL2	16.30	96258162
STYLED L 129W/BP8-34% INT55 CL2	16.20	96258170
STYLED L 77W/BP10-50% EXT55 CL2	16.00	96259022
STYLED L 77W/BP10-50% EXT55WB CL2	16.00	96259021
STYLED L 77W/BP10-50% INT55 CL2	16.00	96259023
STYLED L 77W/BP6-25% EXT55 CL2	16.00	96259019
STYLED L 77W/BP6-25% EXT55WB CL2	16.00	96259018
STYLED L 77W/BP6-25% INT55 CL2	16.00	96259020
STYLED L 77W/BP8-34% EXT55 CL2	16.00	96258190
STYLED L 77W/BP8-34% EXT55WB CL2	16.00	96258186
STYLED L 77W/BP8-34% INT55 CL2	16.00	96258194
StyLED Long with Telea RF		
STYLED L 103W EXT55 LDRF CL1	16.20	96258233
STYLED L 103W EXT55 LDRF CL2	16.20	96258234
STYLED L 103W EXT55WB LDRF CL1	16.30	96258231
STYLED L 103W EXT55WB LDRF CL2	16.30	96258232
STYLED L 103W INT55 LDRF CL1	16.20	96258235
STYLED L 103W INT55 LDRF CL2	16.20	96258236
STYLED L 129W EXT55 LDRF CL1	16.30	96258227
STYLED L 129W EXT55 LDRF CL2	16.30	96258228
STYLED L 129W EXT55WB LDRF CL1	16.40	96258225
STYLED L 129W EXT55WB LDRF CL2	16.40	96258226
STYLED L 129W INT55 LDRF CL1	16.30	96258229
STYLED L 129W INT55 LDRF CL2	16.30	96258230
STYLED L 77W EXT55 LDRF CL1	16.10	96258239
STYLED L 77W EXT55 LDRF CL2	16.10	96258240
STYLED L 77W EXT55WB LDRF CL1	16.10	96258237
STYLED L 77W EXT55WB LDRF CL2	16.10	96258238
STYLED L 77W INT55 LDRF CL1	16.10	96258241
STYLED L 77W INT55 LDRF CL2	16.10	96258242

Description	Wt (kg)	SAP Code
StyLED Brackets		
STYLED BRA COL (-2M)		96258746
STYLED BRA MWA		96258744
STYLED BRAX1 MA60 1.00M	7.40	96258739
STYLED BRAX1 MA60 MTP	3.70	96258737
STYLED BRAX2 MA60 1.00M	12.30	96258740
STYLED BRAX2 MA60 MTP	4.10	96258738

CL1 - Class I electrical, CL2 - Class II electrical, MTP - Post-top mounting, MWA - Wall mounted only, EXT - Extensive, INT - Intensive, PM - Integral mini photocell, WB - With baffle, COL - Column, BRA - Bracket LDRF - Controller Radio frequency for stepless electronic ballasts, BP - Power reduction x hours

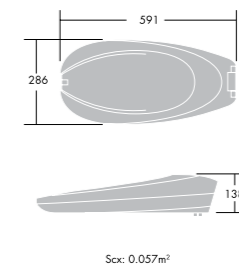
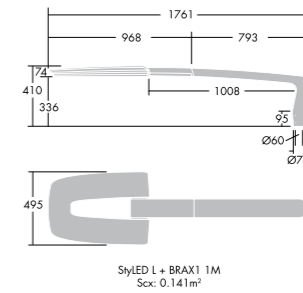
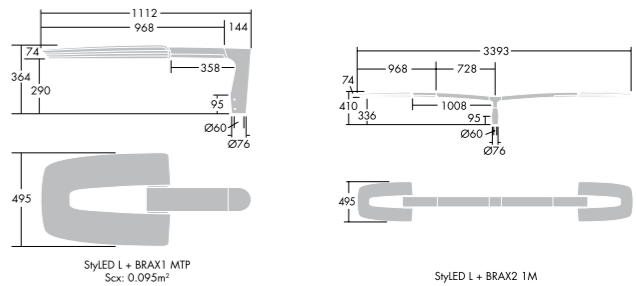
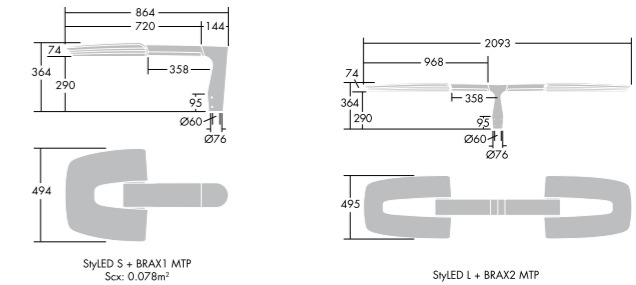

Oxane LED

Description	Wt (kg)	SAP Code
Oxane Class 1		
OXANE 28W CL1	6.36	96259985
OXANE 28W CL1 PM	6.45	96259986
OXANE 56W CL1	6.34	96259989
OXANE 56W CL1 PM	6.43	96259990
OXANE 84W CL1	6.38	96259946
OXANE 84W CL1 PM	6.47	96259947
OXANE 84W CL1 AR	6.38	96259950
OXANE 84W CL1 AR PM	6.47	96259951
Oxane Class 2		
OXANE 28W CL2	6.36	96259995
OXANE 56W CL2	6.34	96259991
OXANE 56W/BP8 CL2	6.34	96259992
OXANE 84W CL2	6.38	96259948
OXANE 84W CL2 AR	6.38	96259647
OXANE 84W/BP8 CL2	6.38	96259949
OXANE 84W AR/BP8 CL2 AR	6.38	96259952

W - Watts, BP8 - Bi power 8hrs @50%, PM - Integral mini photocell, AR - Glass with Anti-reflect, CL1 - Class I electrical, CL2 - Class II electrical

Ordering Guides and Line Drawings

Indra LED

Description	Wt (kg)	SAP Code
Indra Class 1		
INDRA 49W BPL CL1 MA60	4.6	96259900
INDRA 49W BPL CL1 MA76	4.8	96259901
INDRA 49W CL1 PN MA60	4.8	96259902
INDRA 49W CL1 PN MA76	4.9	96259903
INDRA 98W BPL CL1 MA76	8.1	96259906
INDRA 98W BPL CL1 MA60	7.9	96259905
INDRA 98W CL1 PN MA60	7.9	96259907
INDRA 98W CL1 PN MA76	8.1	96259908
Indra Class 2		
INDRA 49W BPL CL2 MA60	4.6	96259899
INDRA 49W BPL CL2 MA76	4.8	96260461
INDRA 98W BPL CL2 MA60	7.9	96259904
INDRA 98W BPL CL2 MA76	7.9	96260462

BPL - Bi power line, PN - Integrate photocell nema socket, MA - Mounting adaptor, CL1 - Class I electrical, CL2 - Class II electrical

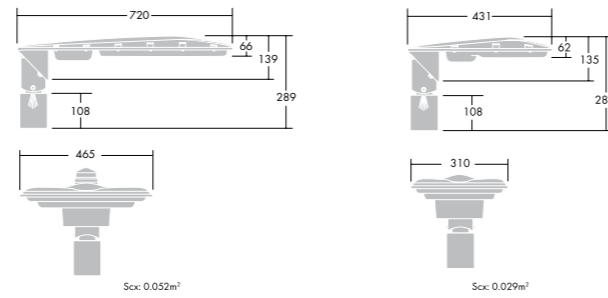

Dyana LED

Description	Wt (kg)	SAP Code
Dyana LED Post top mounting, street optic		
DYANA LED 39W/BP CL1 MTP STREET	11.20	96259170
DYANA LED 39W/BP CL2 MTP STREET	11.20	96259180
DYANA LED 58W/BP CL1 MTP STREET	11.20	96259172
DYANA LED 58W/BP CL2 MTP STREET	11.30	96259182
DYANA LED 58W/LDRF CL1 MTP STREET	11.40	96259179
DYANA LED 58W/LDRF CL2 MTP STREET	11.40	96259189
Dyana LED Post top mounting, area optic		
DYANA LED 39W/BP CL1 MTP A/S	11.20	96259174
DYANA LED 39W/BP CL2 MTP A/S	11.20	96259184
DYANA LED 58W/BP CL1 MTP A/S	11.30	96259176
DYANA LED 58W/BP CL2 MTP A/S	11.30	96259186
Dyana LED Side mounting, street optic		
DYANA LED 39W/BP CL1 MLE STREET	10.70	96259171
DYANA LED 39W/BP CL2 MLE STREET	10.70	96259181
DYANA LED 39W/LDC CL2 MLE STREET	11.10	96259190
DYANA LED 58W/BP CL1 MLE STREET	10.70	96259173
DYANA LED 58W/BP CL2 MLE STREET	10.70	96259183
DYANA LED 58W/LDC CL2 MLE STREET	11.10	96259191
DYANA LED 58W/LDRF CL1 MLE STREET	10.90	96259178
DYANA LED 58W/LDRF CL2 MLE STREET	10.90	96259188
Dyana LED Side mounting, area optic		
DYANA LED 39W/BP CL1 MLE A/S	10.70	96259175
DYANA LED 39W/BP CL2 MLE A/S	10.70	96259185
DYANA LED 39W/LDC CL2 MLE A/S	11.10	96259192
DYANA LED 58W/BP CL1 MLE A/S	10.80	96259177
DYANA LED 58W/BP CL2 MLE A/S	10.80	96259187
DYANA LED 58W/LDC CL2 MLE A/S	11.20	96259193

NB: 60 LED - 5x12 LED, 36 - 3x12 LED, CL1 - Class I electrical, CL2 - Class II electrical, MLE - Side lateral mounting, MTP - Post-top mounting, BP - Bi Power controller, LDRF - Controller Radio frequency for stepless electronic ballasts

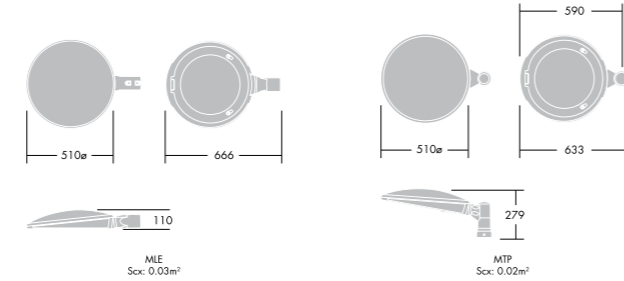

Clan LED

Description	Wt (kg)	SAP Code
Clan O LED lanterns : Street optic		
CLAN O LED 39W/BP CL1 W7M	10.60	96258141
CLAN O LED 39W/BP CL2 F7M	10.60	96258139
CLAN O LED 39W/BP CL2 N7M	10.60	96258137
CLAN O LED 58W/BP CL1 W7M	10.60	96258142
CLAN O LED 58W/BP CL2 F7M	10.60	96258140
CLAN O LED 58W/BP CL2 N7M	10.60	96258138
Clan O LED lanterns : Asymmetric optic		
CLAN O LED 39W/BP CL1 A/S W7M	10.60	96258153
CLAN O LED 39W/BP CL2 A/S F7M	10.60	96258151
CLAN O LED 39W/BP CL2 A/S N7M	10.60	96258149
CLAN O LED 58W/BP CL1 A/S W7M	10.60	96258154
CLAN O LED 58W/BP CL2 A/S F7M	10.60	96258152
CLAN O LED 58W/BP CL2 A/S N7M	10.60	96258150
Clan O LED lanterns : Street optic with basic bracket		
CLAN O LED 39W/BP CL1 W7M BRA	12.50	96258129
CLAN O LED 39W/BP CL2 F7M BRA	12.50	96258127
CLAN O LED 39W/BP CL2 N7M BRA	12.50	96258125
CLAN O LED 58W/BP CL1 W7M BRA	12.50	96258130
CLAN O LED 58W/BP CL2 F7M BRA	12.50	96258128
CLAN O LED 58W/BP CL2 N7M BRA	12.50	96258126
Clan O brackets		
CLAN ADAPTOR 76MM	0.90	96257409
CLAN ARCHI/O BRAX1 MLE	3.70	96257404
CLAN ARCHI/O BRAX1 MTP D60	5.90	96257401
CLAN ARCHI/O BRAX1 MWA	3.40	96257403
CLAN ARCHI/O BRAX2 MTP D60	9.50	96257402
CLAN BASIC/O BRA MTP D60	1.90	96258255
CLAN DECO/O BRAX1 MLE	4.30	96257408
CLAN DECO/O BRAX1 MTP D60	6.20	96257405
CLAN DECO/O BRAX1 MWA	3.90	96257407
CLAN DECO/O BRAX2 MTP D60	8.60	96257406
CLAN MCA BRA 34G		96258089
Clan O accessory		
CLAN O LVBACK	0.12	96257631
Clan Columns		
CLAN COL 3,5M CCO D60 ST MPL FAI GRY	26.00	96258615
CLAN COL 3M CCO D60 ST MPL FAI GRY	22.00	96258614
CLAN COL 4,5M CCO D60 ST MPL FAI GRY	34.00	96258624
CLAN COL 4M CCO D60 ST MPL FAI GRY	30.00	96258620
CLAN COL 5,5M CCO D60 ST MPL FAI GRY	44.30	96258626
CLAN COL 5M CCO D60 ST MPL FAI GRY	37.50	96258625
CLAN COL 6M CCO D60 ST MPL FAI GRY	49.00	96258629

BP - Bi-Power, CL1 - Class I electrical, CL2 - Class II electrical, MLE - Side lateral mounting, MTP - Post top mounting, MWA - Wall mounting, FAI - Anchor bolts, GRY - Grey, N7M - Pre-cabled with 7m H05VV-F 2x1.5m² cable, F7M - Pre-cabled with 7m H07RN-F 2x1.5m² cable, W7M - Pre-cabled with 7m H07RN-F 3x1.5m² cable

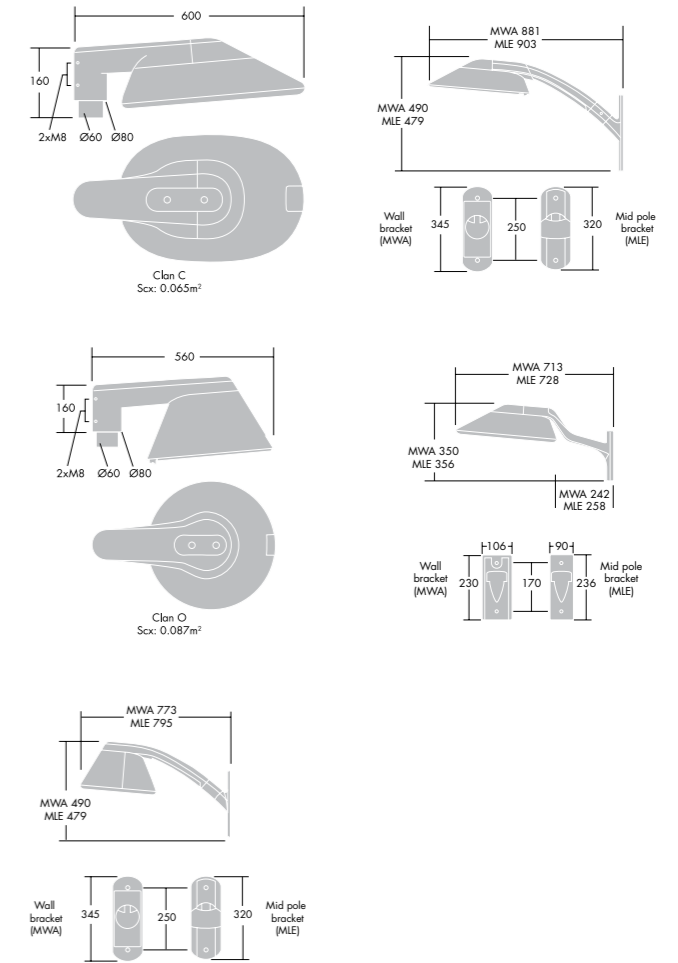

Ordering Guides and Line Drawings

Atla LED

Description	Wt (kg)	SAP Code
Atla LED Luminaires		
ATLA LED LLM 1800 L740 EFL GRY	5.30	96208304
ATLA LED LLM 1800 L740 EFL GRY 8M	5.30	96207893
ATLA LED LLM 1800 L740 ESH GRY	5.30	96208305
ATLA LED LLM 1800 L740 ESH GRY 8M	5.30	96207894

EFL - Flat panel/glass, ESH - Shallow dish or bowl, GRY - Grey

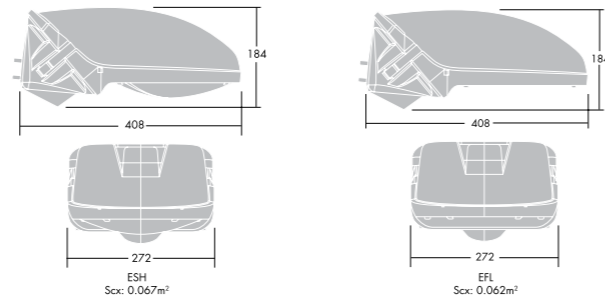

Christian IV LED

Description	Wt (kg)	SAP Code
Post Top		
CHRIV LED LLM 1800 L740 CL2 ANT MTP N8M	8.50	96208462
CHRIV LED LLM 3000 L740 CL2 ANT MTP N8M	8.50	96208463
Side Entry		
CHRIV LED LMM 1800 L740 CL2 ANT MLE N8M	8.50	96208470
CHRIV LED LMM 3000 L740 CL2 ANT MLE N8M	8.50	96208471

CHRIV CUT OFF SHIELD 59004371
CL2 - Class II electrical, ANT - Anthracite (grey), MLE - Side lateral mounting, MTP - Post-top mounting

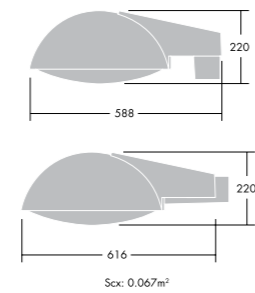

Victor/Victoria LED

Description	Wt (kg)	SAP Code
Victor LED		
VICTOR 1 LED LLM 1800/740	6.80	96208391
VICTOR 1 LED LLM 3000/740	6.80	96208392
Victoria LED		
VICTORIA 1 LED LLM 1800/740	7.10	96208405

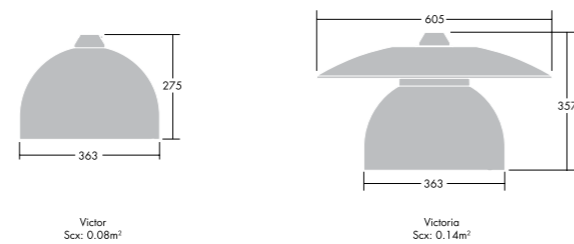

Plurio LED

Description	Wt (kg)	SAP Code
Plurio LED Symmetrical optic, original canopy		
PLURIO O LED 20W CL1 R/S	7.20	96260708
PLURIO O LED 20W CL1 R/S D76	7.50	96260709
PLURIO O LED 20W CL2 R/S	7.20	96260711
PLURIO O LED 20W CL2 R/S D76	7.50	96260713
PLURIO O LED 20W CL2 R/S N4M	7.80	96259972
PLURIO O LED 30W/BP CL1 R/S	7.20	96260722
PLURIO O LED 30W/BP CL1 R/S D76	7.50	96260723
PLURIO O LED 30W/BP CL2 R/S	7.20	96260725
PLURIO O LED 30W/BP CL2 R/S D76	7.50	96260727
PLURIO O LED 30W/BP CL2 R/S N4M	8.00	96260865
PLURIO O LED 40W/BP CL1 R/S	7.20	96260674
PLURIO O LED 40W/BP CL1 R/S D76	9.80	96260676
PLURIO O LED 40W/BP CL2 R/S	7.20	96260678
PLURIO O LED 40W/BP CL2 R/S D76	7.50	96260680
PLURIO O LED 40W/BP CL2 R/S N4M	7.80	96260704

Plurio LED Symmetrical optic, original bi-colour canopy		
PLURIO O LED 40W/BP CL1 R/S D76 SIL/G	7.50	96260684
PLURIO O LED 40W/BP CL1 R/S SIL/GRY	7.20	96260682
PLURIO O LED 40W/BP CL2 R/S D76 SIL/GRY	7.50	96260688
PLURIO O LED 40W/BP CL2 R/S SIL/GRY	7.20	96260686

Plurio LED Symmetrical optic, round canopy		
PLURIO R LED 20W CL1 R/S D76	7.50	96260716
PLURIO R LED 20W CL2 R/S	7.20	96260718
PLURIO R LED 20W CL2 R/S D76	7.50	96260720
PLURIO R LED 20W CL2 R/S N4M	7.80	96260861
PLURIO R LED 30W/BP CL1 R/S D76	7.50	96260730
PLURIO R LED 30W/BP CL2 R/S	7.20	96260732
PLURIO R LED 30W/BP CL2 R/S D76	7.50	96260734
PLURIO R LED 30W/BP CL2 R/S N4M	7.80	96260864
PLURIO R LED 40W/BP CL1 R/S	7.20	96260690
PLURIO R LED 40W/BP CL1 R/S D76	7.50	96260698
PLURIO R LED 40W/BP CL2 R/S	7.20	96260700
PLURIO R LED 40W/BP CL2 R/S D76	7.50	96260702
PLURIO R LED 40W/BP CL2 R/S N4M	7.80	96260706

Plurio LED Street optic, original canopy		
PLURIO O LED 20W CL1 STR D76	7.50	96260710
PLURIO O LED 20W CL2 STR	7.20	96260712
PLURIO O LED 20W CL2 STR D76	7.50	96260714
PLURIO O LED 20W CL2 STR N4M	7.80	96259969
PLURIO O LED 30W/BP CL1 STR D76	7.50	96260724
PLURIO O LED 30W/BP CL2 STR	7.20	96260726
PLURIO O LED 30W/BP CL2 STR D76	7.50	96260728
PLURIO O LED 30W/BP CL2 STR N4M	8.00	96260866
PLURIO O LED 40W/BP CL1 STR	7.20	96260675
PLURIO O LED 40W/BP CL1 STR D76	7.50	96260677
PLURIO O LED 40W/BP CL2 STR	7.20	96260679
PLURIO O LED 40W/BP CL2 STR N4M	7.80	96260705
PLURIO O LED 40W/BP CL2 STR D76	7.50	96260681

Plurio LED Street optic, original bi-colour canopy		
PLURIO O LED 40W/BP CL1 STR D76 SIL/GRY	7.50	96260685
PLURIO O LED 40W/BP CL1 STR SIL/GRY	7.20	96260683
PLURIO O LED 40W/BP CL2 STR D76 SIL/GRY	7.50	96260689
PLURIO O LED 40W/BP CL2 STR SIL/GRY	7.20	96260687

Plurio LED Street optic, round canopy		
PLURIO R LED 20W CL1 STR	7.20	96260715
PLURIO R LED 20W CL1 STR D76	7.50	96260717
PLURIO R LED 20W CL2 STR	7.20	96260719
PLURIO R LED 20W CL2 STR D76	7.50	96260721
PLURIO R LED 20W CL2 STR N4M	7.80	96260862
PLURIO R LED 30W/BP CL1 STR	7.20	96260729
PLURIO R LED 30W/BP CL1 STR D76	7.50	96260731
PLURIO R LED 30W/BP CL2 STR	7.20	96260733
PLURIO R LED 30W/BP CL2 STR D76	7.50	96260735
PLURIO R LED 30W/BP CL2 STR N4M	7.80	96260863
PLURIO R LED 40W/BP CL1 STR	7.20	96260691
PLURIO R LED 40W/BP CL1 STR D76	7.50	96260699
PLURIO R LED 40W/BP CL2 STR	7.20	96260701
PLURIO R LED 40W/BP CL2 STR D76	7.50	96260703
PLURIO R LED 40W/BP CL2 STR N4M	7.80	96260707

CL1 - Class I electrical, CL2 - Class II electrical, BP - Bi Power, GRY - Grey, SIL - Silver, STR - Street, N4M - Pre-cabled with 4m H05VVf 2x1.5m² cable, R/S - Radial - symmetric in all horizontal planes, D76 - Diameter 76mm

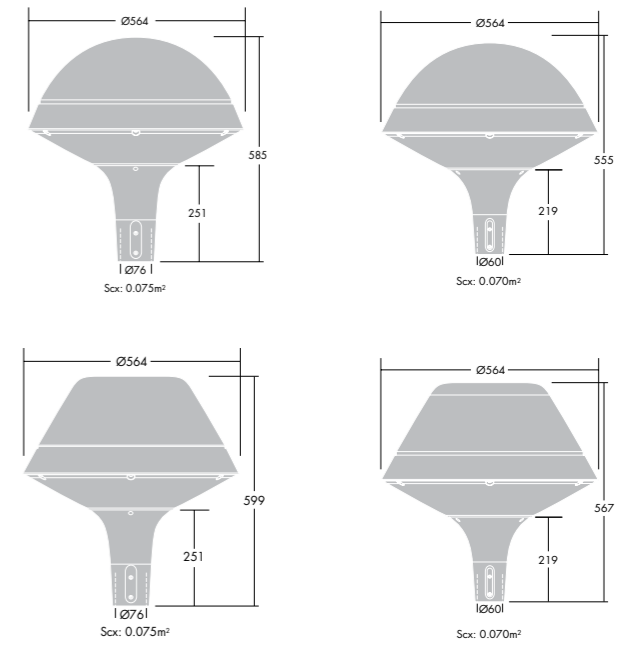

Ordering Guides and Line Drawings

Adelie LED

Description	Wt (kg)	SAP Code
Lantern (with driver)		
ADELIE 51W LED 3800K CL2	7.50	96257121
ADELIE 51W LED 5200K CL2	7.50	96254108
Dedicated aluminium column		
ADELIE COL 3M MGR CCO AL GRY	10.50	96254574
ADELIE COL 3M MGS CCO AL GRY	12.20	96254575
ADELIE COL 3M MPL CCO AL FAI GRY	11.90	96254572
Connection box		
TEMPO16 CL2 4X16 2 WIRES	0.34	96008411

CL2 - Class II electrical, MPL - Post top column with flange plate, MGR - Post top column with Root, MGS - Post column with ground spike, FAI - bolts included

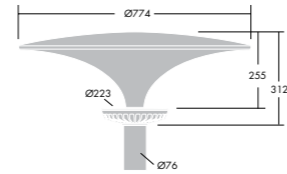

Nella LED

Description	Wt (kg)	SAP Code
Nella LED		
NELLA LED 37W 4000K	4.60	96259610

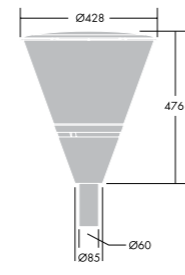

Scal: 0.143m²

Alumet Stage LED

Description	Wt (kg)	SAP Code
Head		
ALUMET STAGE 84W LEDS CL2 CL	17.00	96255204
LED modules		
ALUMET STAGE 17W LED A INT	0.29	96255224
ALUMET STAGE 17W LED B INT	0.29	96255221
ALUMET STAGE 17W LED G INT	0.29	96255222
ALUMET STAGE 17W LED R INT	0.29	96255223
ALUMET STAGE 17W LED WC INT	0.29	96255219
ALUMET STAGE 17W LED WC SINT	0.29	96255220
ALUMET STAGE 17W LED WW INT	0.29	96255217
ALUMET STAGE 17W LED WW SINT	0.29	96255218
Column		
ALUMET COL 3M MGR AL SIL NG	38.00	96259923
ALUMET COL 3M MGS AL SIL NG	35.00	96259918
ALUMET COL 3M MPL AL FAI SIL NG	35.00	96259919
ALUMET COL 4M MGR AL SIL NG	37.20	96259920
ALUMET COL 4M MGS AL SIL NG	37.20	96259921
ALUMET COL 4M MPL AL FAI SIL NG	36.00	96259922
Lampshields		
ALUMET LAMP SHIELD 180° ARABESQUE	3.45	96255210
ALUMET LAMP SHIELD 180° SQUARE	3.60	96254469
Accessories		
ALUMET STAGE FILTER B	0.08	96255211
ALUMET STAGE FILTER G	0.08	96255213
ALUMET STAGE FILTER R	0.08	96255212
ALUMET STAGE FILTER Y	0.08	96255214
ALUMET STAGE LR	0.12	96255215
ALUMET STAGE LV	0.07	96255216

CL2 - Class II electrical, MPL - Post top column with flange plate, MGR - Post top column with Root, MGS - Post column with ground spike, FAI - bolts included, WW - Warm white, WC - Cold white, INT - Intensive, SINT - Semi-intensive, B - Blue, G - Green, R - Red, A - Amber, Y - yellow, LR - Refractor, LV - Anti-glare louvre

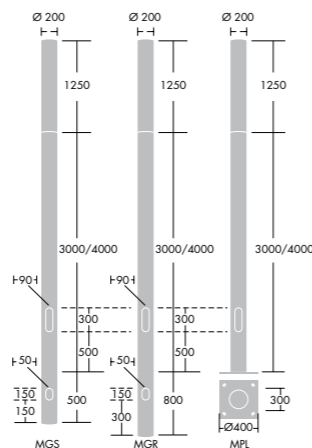

Promenade LED

Description	Wt (kg)	SAP Code
Promenade Flange mounted		
PROMENADE BOL LED WHI/AMB 1150MM MPL ANT	12.00	96250884
PROMENADE BOL LED WHI/BLU 1150MM MPL ANT	12.00	96250887
PROMENADE BOL LED WHI/GRN 1150MM MPL ANT	12.00	96250886
PROMENADE BOL LED WHI/RED 1150MM MPL ANT	12.00	96250885
PROMENADE BOL LED WHI/WHI 1150MM MPL ANT	12.00	96252596
Promenade Parapet mounted		
PROMENADE BOL LED WHI/AMB 325MM MPL ANT	7.40	96231685
PROMENADE BOL LED WHI/BLU 325MM MPL ANT	7.40	96231682
PROMENADE BOL LED WHI/GRN 325MM MPL ANT	7.40	96231683
PROMENADE BOL LED WHI/RED 325MM MPL ANT	7.40	96231684
PROMENADE BOL LED WHI/WHI 325MM MPL ANT	7.40	96252597
Promenade Root mounted attachments		
AVENUE/PROMENADE/MADISON BOL MGR SPIKE	10.00	96005367
PROMENADE/AVENUE BASE MGS	10.00	96100253

Promenade Gears and parts for retrofit		
PROMENADE GT 1150MM LED WHI/AMB	1.70	96231680
PROMENADE GT 1150MM LED WHI/BLU	1.70	96231677
PROMENADE GT 1150MM LED WHI/GRN	1.70	96231679
PROMENADE GT 1150MM LED WHI/RED	1.70	96231678

MPL - Post-column with flange plate, MGR - Post-column with root, MGS - Post-column with ground spike, ANT - Anthracite, WHI - White, AMB - Amber, BLU - Blue, GRN - Green,

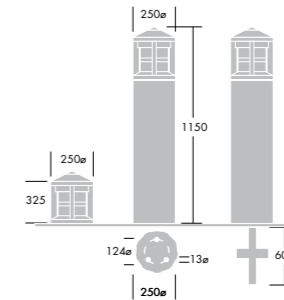

Avenue F LED

Description	Rotational symmetrical optic (R/S)		Street optic (STR)	
	Weight (Kg)	SAP Code	Weight (Kg)	SAP Code
LED versions				
I AVENUE F LED 20W CL1	9.0	96260051	9.3	96260087
AVENUE F LED 30W CL1	9.0	96260052	9.3	96260088
AVENUE F LED 40W CL1	9.0	96260053	9.3	96260089
II AVENUE F LED 20W CL2	9.0	96260054	9.3	96260090
AVENUE F LED 30W CL2	9.0	96260055	9.3	96260091
AVENUE F LED 40W CL2	9.0	96260056	9.3	96260092
AVENUE F LED 20W CL2 N4M*	9.4	-	9.7	96260093
AVENUE F LED 30W CL2 N4M*	9.4	96260058	9.7	96260094
AVENUE F LED 40W CL2 N4M*	9.4	96259973	9.7	96260095
LED versions with power reduction				
I AVENUE F LED 20W/BP CL1	9.0	96260128	9.3	96260231
AVENUE F LED 30W/BP CL1	9.0	96260127	9.3	96260232
AVENUE F LED 40W/BP CL1	9.0	96260059	9.3	96260096
AVENUE F LED 40W/BP CL1 D76	9.1	96260021	9.2	96260033
AVENUE F LED 40W/BP CL1 PM D76	9.1	96260022	9.3	96260034
II AVENUE F LED 20W/BP CL2	-	-	9.3	96260097
AVENUE F LED 30W/BP CL2	9.0	96260061	9.3	96260098
AVENUE F LED 40W/BP CL2	9.0	96260062	9.3	96260099
AVENUE F LED 30W/BP CL2 N4M*	9.4	-	9.7	96260101
AVENUE F LED 40W/BP CL2 N4M*	9.4	96260065	9.7	96260102

CL1 - Class I electrical, CL2 - Class II electrical, BP - Bi Power, PM - Integral mini photocell

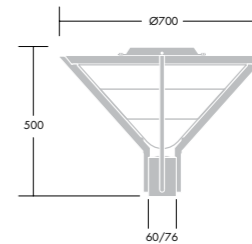

Ordering Guides and Line Drawings

Mica Slim LED

Description	Wt (kg)	SAP Code
Mica Slim SS LED		
MICA SLIM SS 1,2W SOFT LED WHI 6K RS FR	1.5	96257369
MICA SLIM SS 1,2W SOFT LED WHI 3K RS FR	1.5	96257370
MICA SLIM SS 1,2W SOFT LED BLU RS FR	1.5	96257371
MICA SLIM SS 1,2W SOFT LED WHI 6K AL FR	1.4	96257372
MICA SLIM SS 1,2W SOFT LED WHI 3K AL FR	1.4	96257373
MICA SLIM SS 1,2W SOFT LED BLU AL FR	1.4	96257374
MICA SLIM SS 1,2W ACC 7DLED W 6K RS SF	2.1	96503614
MICA SLIM SS 1,2W ACC 7DLED W 3K RS SF	2.1	96257418
MICA SLIM SS 1,2W ACC 7DLED BLU RS SF	2.1	96503615
MICA SLIM SS 1,2W ACC 7DLED W 6K AL SF	1.9	96257419
MICA SLIM SS 1,2W ACC 7DLED W 3K AL SF	1.9	96257420
MICA SLIM SS 1,2W ACC 7DLED BLU AL SF	1.9	96257421
MICA SLIM SS 1,2W 1LED WHI 6K EDO EW1	1.9	96503619
MICA SLIM SS 1,2W 1LED BLU EDO EW1	1.9	96503620
MICA SLIM SS 1,2W 1LED WHI 6K EDO EW2	1.9	96503624
MICA SLIM SS 1,2W 1LED BLU EDO EW2	1.9	96503625
MICA SLIM SS 1,2W 1LED WHI 6K EDO EW8	1.9	96503629
MICA SLIM SS 1,2W 1LED BLU EDO EW8	1.9	96503630
MICA SLIM SS 1,2W 1LED WHI 3K EDO EW1	1.9	96257422
MICA SLIM SS 1,2W 1LED WHI 3K EDO EW2	1.9	96257423
MICA SLIM SS 1,2W 1LED WHI 3K EDO EW8	1.9	96257424
MICA SLIM SS 1X1,2W ACC 24DLED W 6K AL SF	1.9	96260379
MICA SLIM SS 1X1,2W ACC 24DLED W 6K RS SF	2.1	96260380
MICA SLIM SS 1X1,2W ACC 24DLED W 3K AL SF	1.9	96260381
MICA SLIM SS 1X1,2W ACC 24DLED W 3K RS SF	2.1	96260382
MICA SLIM SS 1X1,2W ACC LED BLU 24D AL SF	1.9	96260383
MICA SLIM SS 1X1,2W ACC LED BLU 24D RS SF	2.1	96260384
Mica Slim S LED		
MICA SLIM S 3X1,2W SOFT LED WHI 6K RS FR	2.4	96257426
MICA SLIM S 3X1,2W SOFT LED WHI 3K RS FR	2.4	96257427
MICA SLIM S 3X1,2W SOFT LED BLU RS FR	2.4	96257428
MICA SLIM S 3X1,2W SOFT LED WHI 6K AL FR	2.1	96257429
MICA SLIM S 3X1,2W SOFT LED WHI 3K AL FR	2.1	96257430
MICA SLIM S 3X1,2W SOFT LED BLU AL FR	2.1	96257431
MICA SLIM S 3X1,2W ACC 10DLED W 6K RS SF	2.6	96503636
MICA SLIM S 3X1,2W ACC 10DLED W 3K RS SF	2.6	96257433
MICA SLIM S 3X1,2W ACC 10DLED BLU RS SF	2.6	96503637
MICA SLIM S 3X1,2W ACC 10DLED W 6K AL SF	2.2	96257434
MICA SLIM S 3X1,2W ACC 10DLED W 3K AL SF	2.2	96257435
MICA SLIM S 3X1,2W ACC 10DLED BLU AL SF	2.2	96257436
MICA SLIM S 3X1,2W ACC 24DLED W 6K AL SF	2.2	96260385
MICA SLIM S 3X1,2W ACC 24DLED W 6K RS SF	2.6	96260386
MICA SLIM S 3X1,2W ACC 24DLED W 3K AL SF	2.2	96260387
MICA SLIM S 3X1,2W ACC 24DLED W 3K RS SF	2.6	96260388
MICA SLIM S 3X1,2W ACC LED BLU 24D AL SF	2.2	96260389
MICA SLIM S 3X1,2W ACC LED BLU 24D RS SF	2.6	96260390
Mica Slim A LED		
MICA SLIM A 4X2W SOFT LED WHI 6K RS FR	5.1	96257441
MICA SLIM A 4X2W SOFT LED WHI 3K RS FR	5.1	96257442
MICA SLIM A 4X2W SOFT LED BLU RS FR	5.1	96257443
MICA SLIM A 4X2W SOFT LED WHI 6K AL FR	4.2	96257444
MICA SLIM A 4X2W SOFT LED WHI 3K AL FR	4.2	96257445
MICA SLIM A 4X2W SOFT LED BLU AL FR	4.2	96257446
MICA SLIM A 4X2W ACC 7D LED W 6K RS SF	5.1	96257454
MICA SLIM A 4X2W ACC 7D LED W 3K RS SF	5.1	96257455
MICA SLIM A 4X2W ACC 7D LED BLU RS SF	5.1	96257456
MICA SLIM A 4X2W ACC 7D LED W 6K AL SF	4.3	96257457
MICA SLIM A 4X2W ACC 7D LED W 3K AL SF	4.3	96257458
MICA SLIM A 4X2W ACC 7D LED BLU AL SF	4.3	96257459
MICA SLIM A 4X2W ACC 24D LED W 6K AL SF	4.3	96260391
MICA SLIM A 4X2W ACC 24D LED W 6K RS SF	5.1	96260392
MICA SLIM A 4X2W ACC 24D LED W 3K AL SF	4.3	96260393
MICA SLIM A 4X2W ACC 24D LED W 3K RS SF	5.1	96260394
MICA SLIM A 4X2W ACC LED BLU 24D AL SF	4.3	96260395
MICA SLIM A 4X2W ACC LED BLU 24D RS SF	5.1	96260396

Description	Wt (kg)	SAP Code
Mica Slim I LED		
MICA SLIM I 7X2W ACC 7D LED W 6K AL SF	7.5	96257470
MICA SLIM I 7X2W ACC 7D LED W 6K RS SF	8.8	96257471
MICA SLIM I 7X2W ACC 7D LED W 3K AL SF	7.5	96257472
MICA SLIM I 7X2W ACC 7D LED W 3K RS SF	8.8	96257473
MICA SLIM I 7X2W ACC 7D LED BLU AL SF	7.5	96257474
MICA SLIM I 7X2W ACC 7D LED BLU RS SF	8.8	96257476
MICA SLIM I 7X2W ACC LEDS RGB AL SF	9.0	96260600
MICA SLIM I 7X2W ACC LEDS RGB RS SF	9.0	96260601
MICA SLIM I 7X2W SOFT LED WHI 6K AL FR	7.3	96257478
MICA SLIM I 7X2W SOFT LED WHI 6K RS FR	8.6	96257479
MICA SLIM I 7X2W SOFT LED WHI 3K AL FR	7.3	96257480
MICA SLIM I 7X2W SOFT LED WHI 3K RS FR	8.6	96257481
MICA SLIM I 7X2W SOFT LED BLU AL FR	7.3	96257482
MICA SLIM I 7X2W SOFT LED BLU RS FR	8.6	96257483
MICA SLIM I 4X3X1,2W SOFT LEDS RGB AL FR	9.0	96260602
MICA SLIM I 4X3X1,2W SOFT LEDS RGB RS FR	9.0	96260603
MICA SLIM I 7X2W ACC 24D LED W 6K AL SF	7.5	96260397
MICA SLIM I 7X2W ACC 24D LED W 6K RS SF	8.8	96260398
MICA SLIM I 7X2W ACC 24D LED W 3K AL SF	7.5	96260399
MICA SLIM I 7X2W ACC 24D LED W 3K RS SF	8.8	96260400
MICA SLIM I 7X2W ACC LED BLU 24D AL SF	7.5	96260401
MICA SLIM I 7X2W ACC LED BLU 24D RS SF	8.8	96260402
Mica Slim LED Accessories		
* MICA SLIM SS/CESAR1 LED HOLO FILM 60X1°	0.02	96260430
* MICA SLIM SS/CESAR1 LED HOLO FILM 60X60°	0.02	96260431
* MICA SLIM SS/CESAR1 LED HOLO FILM 75X45°	0.02	96260432
* MICA SLIM S LED HOLO FILM 60X1°	0.02	96260433
* MICA SLIM S LED HOLO FILM 60X60°	0.02	96260434
* MICA SLIM S LED HOLO FILM 75X45°	0.02	96260435
* MICA SLIM A LED HOLO FILM 60X1°	0.04	96260436
* MICA SLIM A LED HOLO FILM 60X60°	0.04	96260437
* MICA SLIM A LED HOLO FILM 75X45°	0.04	96260438
* MICA SLIM I LED HOLO FILM 60X1°	0.04	96260439
* MICA SLIM I LED HOLO FILM 60X60°	0.04	96260440
* MICA SLIM I LED HOLO FILM 75X45°	0.04	96260441

WHI - White, BLU - Blue, 6K - 6000K, 3K - 3000K, ACC - Accent LED, SOFT - Soft LED, AL - Aluminium, RS - Stainless steel, EDO WIN1 - Dome window with 1 window, SF - Semi-frosted, FR - Frosted, SY - Sylvania lamp, HOLO - Holographic film

* Not suitable for conventional versions.

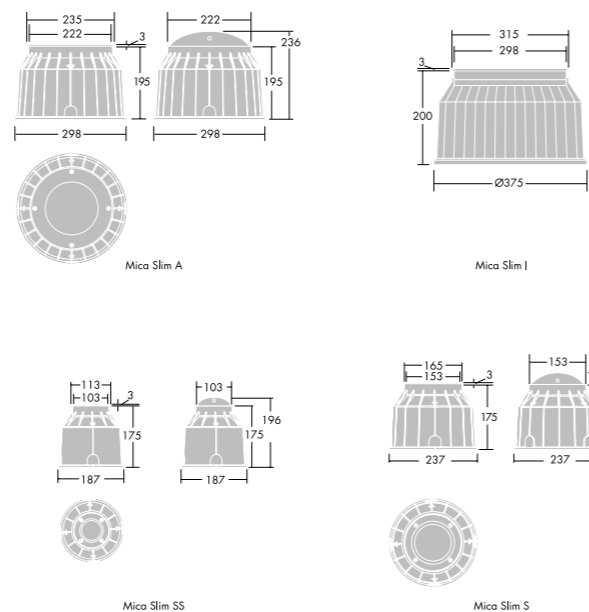

Band LED

Description	Wt (kg)	SAP Code
Band Surface		
BAND WD MWA BLU 1M	2.10	96200713
BAND WD MWA GRN 1M	2.10	96200716
BAND WD MWA RED 1M	2.10	96200714
BAND WD MWA RGB 1M	4.70	96220059
BAND WD MWA WHI 1M	2.10	96200712
BAND WD MWA YEL 1M	2.10	96200715
Band Recessed		
BAND WD MRE BLU 1M	4.70	96200718
BAND WD MRE GRN 1M	4.70	96200721
BAND WD MRE RED 1M	4.70	96200719
BAND WD MRE RGB 1M	6.60	96220061
BAND WD MRE WHI 1M	4.70	96200717
BAND WD MRE YEL 1M	4.70	96200720
Band Accessories		
BAND RGB BOOSTER	1.20	96200723
BAND RGB SEQUENCER	0.60	96200722

MWA - Surface, MRE - Recessed, WHI - White (5500K), BLU - Blue, RED - Red, YEL - Yellow, GRN - Green, RGB - Red, green and blue

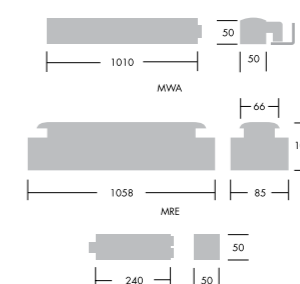

Cesar LED

Description	Wt (kg)	SAP Code
Cesar Size 1 LED, downlight		
CESAR 1 1X3W 230/240V 10D LED 6K WHI	1.7	96231435
CESAR 1 1X3W 230/240V 10D LED BLU	1.7	96231436
CESAR 1 1X3W 230/240V 10D LED GRN	1.7	96231437
CESAR 1 1X3W 230/240V 10D LED RED	1.7	96231438
CESAR 1 1X3W 230/240V 10D LED YEL	1.7	96231439
CESAR 1 2X3W 230/240V 10D LED 6K WHI	1.9	96231452
CESAR 1 2X3W 230/240V 10D LED BLU	1.9	96231453
CESAR 1 2X3W 230/240V 10D LED GRN	1.9	96231454
CESAR 1 2X3W 230/240V 10D LED RED	1.9	96231455
CESAR 1 2X3W 230/240V 10D LED YEL	1.9	96231456
CESAR 1 1X3W 230/240V 10D LED 3K WHI	1.7	96260451
CESAR 1 2X3W 230/240V 10D LED 3K WHI	1.9	96260452
Cesar Accessories		
* MICA SLIM SS/CESAR1 LED HOLO FILM 60X1°	0.02	96260430
* MICA SLIM SS/CESAR1 LED HOLO FILM 60X60°	0.02	96260431
* MICA SLIM SS/CESAR1 LED HOLO FILM 75X45°	0.02	96260432

WHI - White, BLU - Blue, GRN - Green, RED - Red, YEL - Yellow, HOLO - Holographic film

* Not suitable for conventional versions.

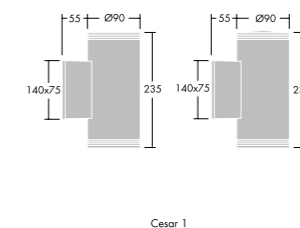

Ordering Guides and Line Drawings

Contrast LED

Description	Wt (kg)	SAP Code
Contrast LED Monochromatic versions		
CONTRAST LED 60W 240V 54LED RED	5.30	96254267
CONTRAST LED 86,6W 240V 54LED BLU	5.30	96254294
CONTRAST LED 86,6W 240V 54LED GRN	5.30	96254268
CONTRAST LED 86,6W 240V 54LED WHI/3000K	5.30	96254293
CONTRAST LED 86,6W 240V 54LED WHI/6000K	5.30	96254292
Contrast LED RGB version		
CONTRAST LED 51,6W 240V 36LED RGB DMX	6.30	96254269
Contrast LED Attachments		
CONTRAST CO/RO AGS (X1)	0.10	96002507
CONTRAST RO AGF	0.70	96216220
CONTRAST RO GL A/S EXT (OMW)	0.80	96002505
CONTRAST RO GL A/S SINT (OMP)	0.90	96002504
CONTRAST RO GL CHROMAT CORRECTION FILTER	0.80	96254526
CONTRAST RO GL S/S XEXT (OME)	0.90	96002506
CONTRAST RO GL/FR S/S SINT (OMS)	0.90	96002503
CONTRAST RO LR1	0.80	96002500
CONTRAST RO LR2	0.80	96002501
CONTRAST RO LR3	0.80	96002502
CONTRAST RO LV	0.60	96002508
CONTRAST RO LV/AJ	0.60	96005841
CONTRAST RO VS	0.10	96002516
CONTRAST RO WG	0.60	96002511

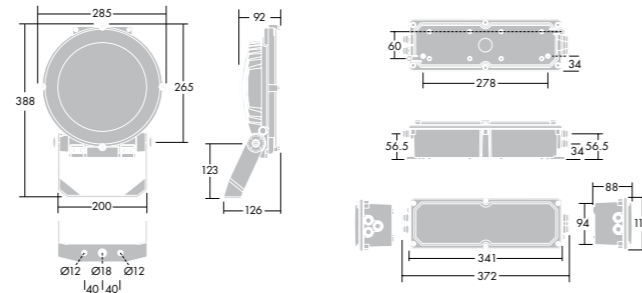

WHI - White, BLU - Blue, RED - Red, GRN - Green, AMB - Amber, RGB - Red, green and blue, AGS - Barndoors, AGF - Spill light controller, GL - Glass, LV - Louvre, AD - Adjustable, VS - Visor, WG - Wireguard, LR - Refractor lens, DMX - Dynamic colour changing

Qba LED

Description	Wt (kg)	SAP Code
Qba LED Monochromatic versions		
QBA LED 24W 240V 18LED AMB	5.30	96254276
QBA LED 24W 240V 18LED BLU	5.30	96254273
QBA LED 24W 240V 18LED GRN	5.30	96254275
QBA LED 24W 240V 18LED RED	5.30	96254274
QBA LED 24W 240V 18LED WHI/3000K	5.30	96254272
QBA LED 24W 240V 18LED WHI/6000K	5.30	96254271
Qba LED RGB version		
QBA LED 36W 240V 8LED RGB DMX	5.10	96254277
Qba LED Attachments		
QBA AGS (X4)	0.40	96012230
QBA FILTER REFR 555B H	0.40	96220098
QBA FILTER REFR 555B V	0.40	96220097
QBA GL CHROMATIC CORRECTION FILTER	0.20	96254527
QBA LV	0.60	96012231
QBA SHORT STIRRUP	0.30	96012236
QBA VS	0.20	96012228
QBA WG	0.20	96012229

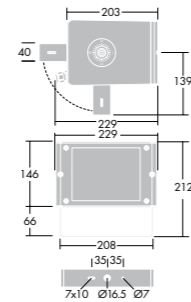

WHI - White, BLU - Blue, RED - Red, GRN - Green, AMB - Amber, RGB - Red, green and blue, AGS - Barndoors, LV - Louvre, VS - Visor, WG - Wireguard, DMX - Dynamic colour changing

D-CO LED

Description	Wt (kg)	SAP Code
D-CO LED Floodlights Size 1		
D-CO F LED FLOOD1 3X1,2W WHI 3K	0.40	96257244
D-CO F LED FLOOD1 3X1,2W WHI 4K	0.40	96257245
D-CO LED Floodlights Size 2		
D-CO F LED FLOOD2 6X1,2W WHI 3K	0.90	96257246
D-CO F LED FLOOD2 6X1,2W WHI 4K	0.90	96257247
D-CO LED Connection boxes		
CON CABLE BOX 2 ENTRIES 1 EXIT IP67	0.30	96257258
CON CABLE BOX 2 ENTRIES 6 EXIT IP67	0.40	96257259

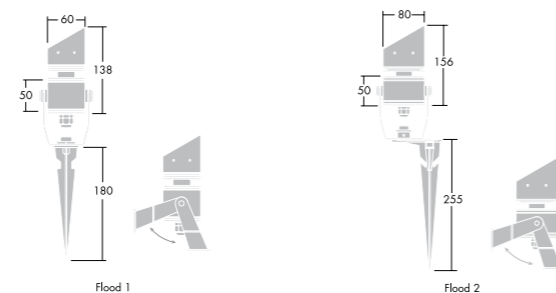

WHI - White LED

Contrast Mini Pinspot LED

Description	Wt (kg)	SAP Code
Contrast Mini Pinspot		
MINI PINSPOT 10D LED 3W RED	0.9	96200734
MINI PINSPOT 10D LED 3W BLU	0.9	96200735
MINI PINSPOT 10D LED 3W GRN	0.9	96200736
MINI PINSPOT 10D LED 3W YEL	0.9	96200737
MINI PINSPOT 10D LED 3W 6K WHI	0.9	96200738
MINI PINSPOT 10D LED 3W 3K WHI	0.9	96260460
Contrast Mini Pinspot LED accessories		
*EFACT RO/MINIPINS LED HOLO FILM 60X1°	0.02	96260415
*EFACT RO/MINIPINS LED HOLO FILM 60X60°	0.02	96260416
*EFACT RO/MINIPINS LED HOLO FILM 75X45°	0.02	96260417

WHI - White, BLU - Blue, RED - Red, GRN - Green, YEL - Yellow, HOLO - Holographic film
*Not suitable for conventional versions.

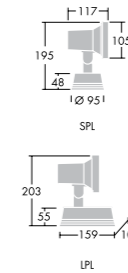

Milo

Description	Wt (kg)	SAP Code
Milo Integral gear floodlights		
MILO I 1X 2,4W 230/240V 1 LED AMB	1.20	96256597
MILO I 1X 2,4W 230/240V 1 LED BLU	1.20	96256592
MILO I 1X 2,4W 230/240V 1 LED GRN	1.20	96256593
MILO I 1X 2,4W 230/240V 1 LED RED	1.20	96256594
MILO I 1X 2,4W 230/240V 1 LED WHI/3000K	1.20	96256596
MILO I 1X 2,4W 230/240V 1 LED WHI/6000K	1.20	96256595
Milo Remote gear floodlights		
MILO R 1X 2,4W LED AMB	0.80	96256603
MILO R 1X 2,4W LED BLU	0.80	96256598
MILO R 1X 2,4W LED GRN	0.80	96256599
MILO R 1X 2,4W LED RED	0.80	96256600
MILO R 1X 2,4W LED WHI/3000K	0.80	96256602
MILO R 1X 2,4W LED WHI/6000K	0.80	96256601
Milo Gears		
MILO R GT 17W 230-240V 0.7A-24V	1.70	96231579
Milo Attachment		
MILO GOBO SUPPORT NM	0.30	96257018

WHI - White, BLU - Blue, RED - Red, GRN - Green, AMB - Amber

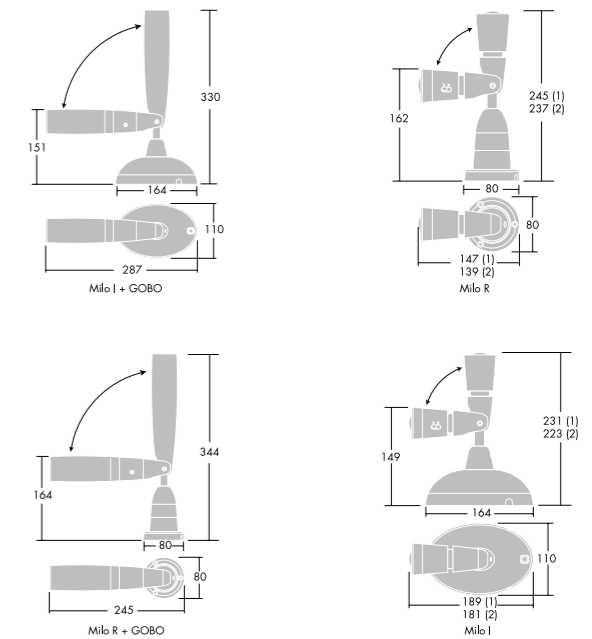

Ordering Guides and Line Drawings

EyeKon LED

Description	Wt (kg)	SAP Code
EyeKon Small with visor, anthracite		
EYE VS 1100 LED OP S ANT L830	2.50	96207642
EYE VS 1100 LED OP S ANT L840	2.50	96207664
EyeKon Small with visor, silver grey		
EYE VS 1100 LED OP S SIL L830	2.50	96207663
EYE VS 1100 LED OP S SIL L840	2.50	96207666
EyeKon Small with visor, black		
EYE VS 1100 LED OP S BL L830	2.50	96207662
EYE VS 1100 LED OP S BL L840	2.50	96207665
EyeKon Small with halo-visor, anthracite		
EYE HA 1100 LED OP S ANT L830	2.50	96207641
EYE HA 1100 LED OP S ANT L840	2.50	96207659
EyeKon Small with halo-visor, silver grey		
EYE HA 1100 LED OP S SIL L830	2.50	96207658
EYE HA 1100 LED OP S SIL L840	2.50	96207661
EyeKon Small with halo-visor, black		
EYE HA 1100 LED OP S BL L830	2.50	96207657
EYE HA 1100 LED OP S BL L840	2.50	96207660

ANT - Anthracite, SIL - Silver, BL - Black, OP - Opal, VS - Visor, HA - Halo

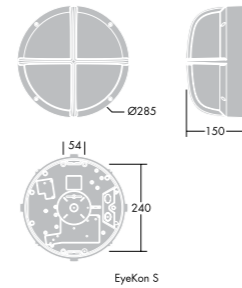

EyeKon S

Leopard LED

Description	Wt (kg)	SAP Code
Leopard LED		
LEOPARD 1250 LED OP RD WH L840	1.30	96240254
LEOPARD 1250 LED MWS OPRD WH L840	1.30	96240255
LEOPARD 1250 LED E3 OP RD WH L840	1.60	96240256
LEOPARD 1250 LED MWS E3 OP RD WH L840	1.60	96240257

WH - White, OP - Opal, MWS - Microwave detector

Menlo³ Circular

Description	Wt (kg)	SAP Code
Menlo³ Circular Dimmable		
MENLO3C LED 3200 HFA WL3 AC	8.70	96239626
MENLO3C LED 3200 HFA WL3 PC	8.70	96239582

AC - Acrylic (PMMA), PC - Polycarbonate, HFA - High frequency-dimmable-analogue

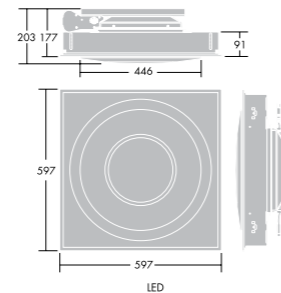

LED

Quattro LED

Description	Wt (kg)	SAP Code
Quattro LED		
QUATTRO LED R600 3200 HFA L935	6.50	96238512
QUATTRO LED R625 3200 HFA L935	6.50	96238513
QUATTRO LED R600 3200 HFA MPT L930	6.80	96238514
QUATTRO LED R625 3200 HFA MPT L930	6.80	96238515

MPT - Micro Prism Technology, HFA - High frequency-dimmable-analogue

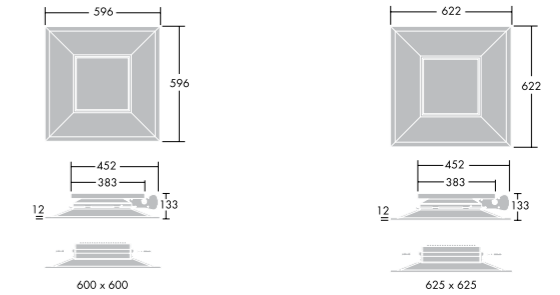

Chalice 190 LED

Description	Wt (kg)	SAP Code 3000K	SAP Code 4000K
Chalice 190 LED			
CHALICE 190H ALU LED 1100 TWIST DTE	1.00	96239850	96239851
CHALICE 190H ALU LED 2000 TWIST DTE	1.80	96239852	96239853
CHALICE 190H ALU LED 1100 HF	1.50	96239842	96239843
CHALICE 190H ALU LED 2000 HF	2.10	96239844	96239845
CHALICE 190H ALU LED 1100 HFX	1.50	96239846	96239847
CHALICE 190H ALU LED 2000 HFX	2.10	96239848	96239849

Accessories*	Wt (kg)	SAP Code
CHALICE 190 CEILING RING SILVER	0.1	96010587
CHALICE 190 GLASS FR SPOT	0.4	96002080
CHALICE 190 GLASS IP44 CL	0.4	96002081
CHALICE 190 GLASS FR	0.4	96004414
CHALICE 190 GLASS 20X4 FR RING	0.5	96002079

ALU - Aluminium reflector, satinbrite, Twist - replacable LED module with 25.000 h lifetime, HF/HFX - Non replacable LED module with 50.000 h lifetime, HF - Electronic ballast, fixed output DTE - Trailing edge dimmable electronic ballast, HFX - DALI dimmable electronic ballast, stepless dimming
FR SPOT - Glass diffuser IP20 or IP44, GLASS IP44 CL - Clear glass diffuser in IP20 / IP44, GLASS FR - Glass diffuser IP20 or IP44 frosted, GLASS 20x4 FR RING - Double halo frosted glass ring, IP20

* More accessories available see website

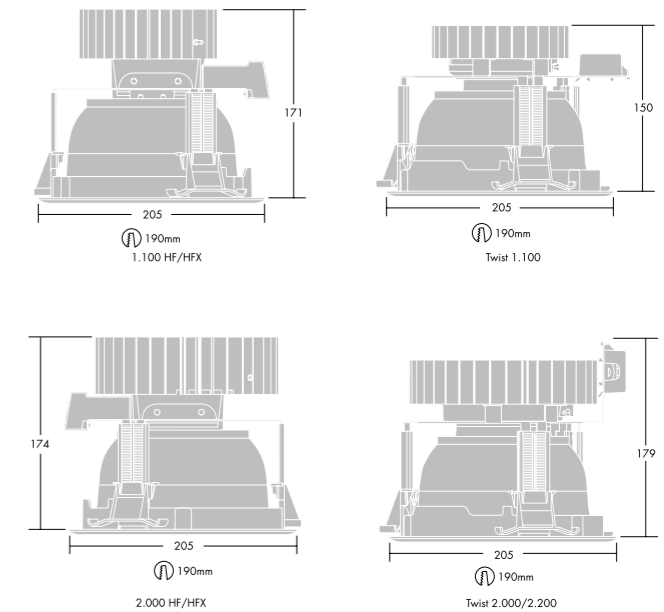

Ordering Guides and Line Drawings

Cruz 160 LED

Description	Wt (kg)	SAP Code
Cruz 160 LED		
CRUZ 160 1X34W LED L840 HFX	1.80	96107638
CRUZ 160 1X37W LED L830 HFX	1.80	96107639

HFX - High frequency-dimmable-addressable (eg DALI)

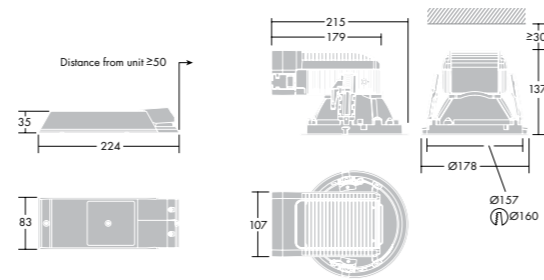

Base LED

Description	Wt (kg)	SAP Code
Base LED Recessed luminaire		
BASELED 165 MRE 1X12W LED L927	1.40	96107294
BASELED 165 MRE 1X12W LED L935	1.40	96107303
BASELED 1K 165 MRE 18W LED L927 HFX	1.40	96107983
BASELED 1K 165 MRE 18W LED L935 HFX	1.40	96107984
Base LED Recessed emergency luminaire		
BASELED 22 MRE 1X3W LED E3NMR	1.30	96107359
Base LED Surface mounted luminaire		
BASELED 165 MCE 1X12W LED L927	2.10	96107308
BASELED 165 MCE 1X12W LED L935	2.10	96107310
BASELED 1K 165 MCE 18W LED L927 HFX	2.20	96107987
BASELED 1K 165 MCE 18W LED L935 HFX	2.20	96107988
Base LED Accessories		
BASELED 165 CONCRETE MTG BOX TOP	0.001	96107320
BASELED 165 WHI BEZELRING RSB	0.10	96107394
BASELED 165 WHI BEZELRING WHI	0.10	96107393
BASELED WHI 165 BEZELRING E1TX/E3TX RSB	0.08	96107633
BASELED WHI 165 BEZELRING E1TX/E3TX WHI	0.08	96107632
BASELED 1K 165 WHI BEZELRING RMB	0.10	96107995
BASELED 1K 165 WHI BEZELRING RSB	0.10	96107994
BASELED 1K 165 WHI BEZELRING WHI	0.10	96107993

* Standard product comes complete with white bezel. Decorative inner ring may be used for enhanced appearance - select and order separately.
WHI - matt white decorative inner ring, E3X - emergency 3hr addressable test, MRE - Recessed, MCE - Surfaced, RSB - Satin, RMB - Specular polished

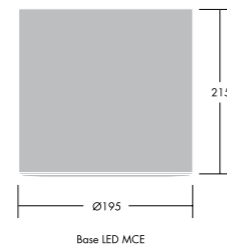
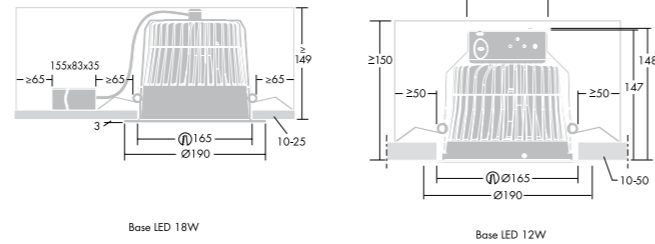

Base LED Junior

Description	Wt (kg)	SAP Code
BASELED JUNIOR 100 L 11,5W LED L930 230V	0.4	96108356
BASELED JUNIOR 100 H 11,5W LED L930 230V	0.4	96108358

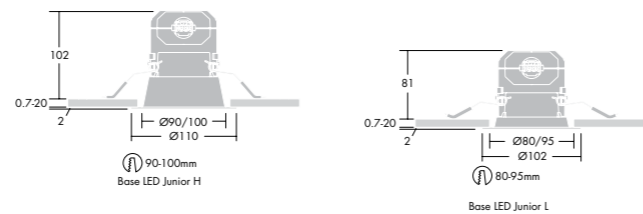

Lightstream 2

Description	Wt (kg)	SAP Code	Cat. No.
LED 8.5W dimmable - fire rated, IP20			
LS2 FH 8,5W LED PAR16 IP20 WHI 830	0.3	96547949	LSF8LFW30
LS2 FH 8,5W LED PAR16 IP20 WHI 842	0.3	96547950	LSF8LFW42
LS2 FH 8,5W LED PAR16 IP20 SN 830	0.3	96547951	LSF8LFS30
LS2 FH 8,5W LED PAR16 IP20 SN 842	0.3	96547952	LSF8LFS42
LS2 FH 8,5W LED PAR16 IP20 CHR 830	0.3	96547953	LSF8LFC30
LS2 FH 8,5W LED PAR16 IP20 CHR 842	0.3	96547954	LSF8LFC42
LED 8.5W dimmable - fire rated, IP65			
LS2 FH 8,5W LED PAR16 IP65 WHI 830	0.4	96547955	LSF8LF65W30
LS2 FH 8,5W LED PAR16 IP65 WHI 842	0.4	96547956	LSF8LF65W42
LS2 FH 8,5W LED PAR16 IP65 SN 830	0.4	96547957	LSF8LF65S30
LS2 FH 8,5W LED PAR16 IP65 SN 842	0.4	96547958	LSF8LF65S42
LS2 FH 8,5W LED PAR16 IP65 CHR 830	0.4	96547959	LSF8LF65C30
LS2 FH 8,5W LED PAR16 IP65 CHR 842	0.4	96547960	LSF8LF65C42
LED 8.5W dimmable - adjustable 0-30°			
LS2 8,5W LED PAR16 IP20 WHI 830 0-30°	0.2	96547965	LS8LAW30
LS2 8,5W LED PAR16 IP20 WHI 842 0-30°	0.2	96547966	LS8LAW42
LS2 8,5W LED PAR16 IP20 SN 830 0-30°	0.2	96547967	LS8LAS30
LS2 8,5W LED PAR16 IP20 SN 842 0-30°	0.2	96547968	LS8LAS42
LS2 8,5W LED PAR16 IP20 CHR 830 0-30°	0.2	96547969	LS8LAC30
LS2 8,5W LED PAR16 IP20 CHR 842 0-30°	0.2	96547970	LS8LAC42
LED 8.5W dimmable - adjustable 0-20°			
LS2 8,5W LED PAR16 IP20 DR WHI 830 0-20°	0.2	96547971	LS8LDW30
LS2 8,5W LED PAR16 IP20 DR WHI 842 0-20°	0.2	96547972	LS8LDW42
LS2 8,5W LED PAR16 IP20 DR SN 830 0-20°	0.2	96547973	LS8LDAS30
LS2 8,5W LED PAR16 IP20 DR SN 842 0-20°	0.2	96547974	LS8LDAS42
LS2 8,5W LED PAR16 IP20 DR CHR 830 0-20°	0.2	96547975	LS8LDAC30
LS2 8,5W LED PAR16 IP20 DR CHR 842 0-20°	0.2	96547976	LS8LDAC42
LED 6W fixed - fire rated, IP20			
LS2 FH 6W LED PAR16 IP20 WHI 830	0.3	96547977	LSF6LFW30
LS2 FH 6W LED PAR16 IP20 WHI 840	0.3	96547978	LSF6LFW40
LS2 FH 6W LED PAR16 IP20 SN 830	0.3	96547979	LSF6LFS30
LS2 FH 6W LED PAR16 IP20 SN 840	0.3	96547980	LSF6LFS40
LS2 FH 6W LED PAR16 IP20 CHR 830	0.3	96547981	LSF6LFC30
LS2 FH 6W LED PAR16 IP20 CHR 840	0.3	96547982	LSF6LFC40
LED 6W fixed - fire rated, IP65			
LS2 FH 6W LED PAR16 IP65 WHI 830	0.4	96547983	LSF6LF65W30
LS2 FH 6W LED PAR16 IP65 WHI 840	0.4	96547984	LSF6LF65W40
LS2 FH 6W LED PAR16 IP65 SN 830	0.4	96547985	LSF6LF65S30
LS2 FH 6W LED PAR16 IP65 SN 840	0.4	96547986	LSF6LF65S40
LS2 FH 6W LED PAR16 IP65 CHR 830	0.4	96547987	LSF6LF65C30
LS2 FH 6W LED PAR16 IP65 CHR 840	0.4	96547988	LSF6LF65C40
Spare lamps			
LS2 LED LAMP 8,5W GU10 HFA 830	0.1	59004139	LS8.5LED30
LS2 LED LAMP 8,5W GU10 HFA 842	0.1	59004149	LS8.5LED42
LS2 LED LAMP 6W GU10 HF 830	0.1	59004140	LS6LED30
LS2 LED LAMP 6W GU10 HF 840	0.1	59004150	LS6LED40

WHI - White, CHR - Chrome, SN - Satin, FH - Fire hood, DR - Deep recessed

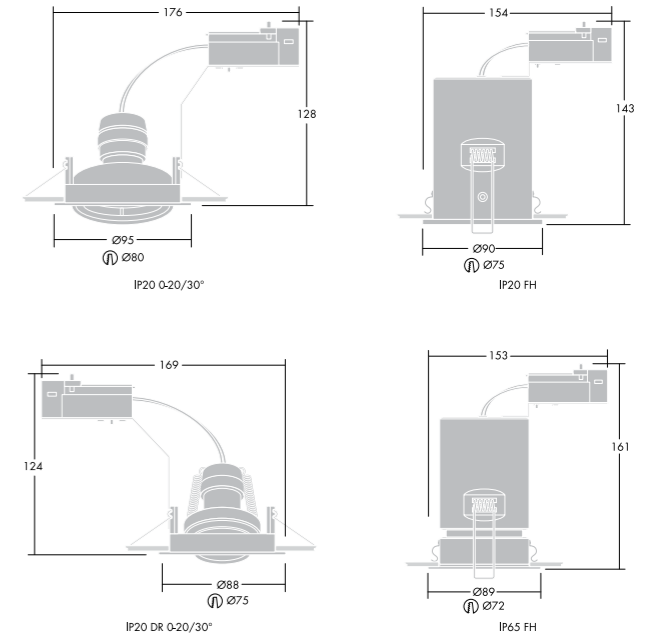

Ordering Guides and Line Drawings

D-CO LED Downlights

Description	Wt (kg)	SAP Code
D-CO LED Downlight 1.2W mini		
D-CO LED MINI DL 1X1,2W 3K 20° 350MA GRY	0.09	96107427
D-CO LED MINI DL 1X1,2W 4K 20° 350MA GRY	0.04	96107428
D-CO LED MINI DL 5/1X1,2W 3K20° 230V KIT	0.28	96107429
D-CO LED MINI DL 5/1X1,2W 4K20° 230V KIT	0.28	96107430
D-CO LED Downlight 3 x 1.2 W		
D-CO LED DL 3/3X1,2W 3K 24° 230V KIT GRY	0.54	96107438
D-CO LED DL 3/3X1,2W 3K 35° 230V KIT GRY	0.54	96107439
D-CO LED DL 3/3X1,2W 4K 24° 230V KIT GRY	0.54	96107441
D-CO LED DL 3/3X1,2W 4K 35° 230V KIT GRY	0.54	96107442
D-CO LED DL 3X1,2W 3K 24° 350MA GRY	0.14	96107432
D-CO LED DL 3X1,2W 3K 35° 350MA GRY	0.14	96107433
D-CO LED DL 3X1,2W 4K 24° 350MA GRY	0.14	96107435
D-CO LED DL 3X1,2W 4K 35° 350MA GRY	0.14	96107436
D-CO LED Downlight 3 x 3W		
D-CO LED DL 3X3W 3K 60° 230V GRY	0.30	96107861
D-CO LED DL 3X3W 3K 60° 230V WHI	0.30	96107863
D-CO LED DL 3X3W 4K 60° 230V GRY	0.30	96107862
D-CO LED DL 3X3W 4K 60° 230V WHI	0.30	96107864
D-CO LED Downlight 3 x 3W without driver		
D-CO LED DL 3X3W 3K 60° 700MA GRY	0.18	96107975
D-CO LED DL 3X3W 3K 60° 700MA WHI	0.18	96107976
D-CO LED Downlight 6 x 1.2W		
D-CO LED DL 6X1,2W 3K 24° 230V GRY	0.28	96107444
D-CO LED DL 6X1,2W 3K 24° 230V WHI	0.28	96107847
D-CO LED DL 6X1,2W 3K 35° 230V GRY	0.28	96107445
D-CO LED DL 6X1,2W 3K 35° 230V WHI	0.28	96107848
D-CO LED DL 6X1,2W 4K 24° 230V GRY	0.28	96107447
D-CO LED DL 6X1,2W 4K 24° 230V WHI	0.28	96107850
D-CO LED DL 6X1,2W 4K 35° 230V GRY	0.28	96107448
D-CO LED DL 6X1,2W 4K 35° 230V WHI	0.28	96107851
D-CO LED Downlight 6 x 1.2W without driver		
D-CO LED DL 6X1,2W 3K 24° 350MA WHI	0.22	96107970
D-CO LED DL 6X1,2W 3K 35° 350MA WHI	0.22	96107971
D-CO LED DL 6X1,2W GYRO 3K 24° 350MA WHI	0.27	96107973
D-CO LED DL 6X1,2W GYRO 3K 35° 350MA WHI	0.27	96107974
D-CO LED Downlight 6 x 1.2W gyro		
D-CO LED DL 6X1,2W GYRO 3K 24° 230V GRY	0.33	96107450
D-CO LED DL 6X1,2W GYRO 3K 24° 230V WHI	0.33	96107853
D-CO LED DL 6X1,2W GYRO 3K 35° 230V GRY	0.33	96107451
D-CO LED DL 6X1,2W GYRO 3K 35° 230V WHI	0.33	96107854
D-CO LED DL 6X1,2W GYRO 4K 24° 230V GRY	0.33	96107453
D-CO LED DL 6X1,2W GYRO 4K 24° 230V WHI	0.33	96107856
D-CO LED DL 6X1,2W GYRO 4K 35° 230V GRY	0.33	96107454
D-CO LED DL 6X1,2W GYRO 4K 35° 230V WHI	0.33	96107857
D-CO LED Downlight Drivers 350mA		
LED CONV 12W 350MA 100-240V 6PLUG	0.14	96107647
LED CONV 15/25W UNI 110-240V DIM	0.11	96107649
LED CONV 50W UNI 110-240V DIM THO	0.15	96108126
LED CONV 50W UNI DALI	0.15	96108026
LED CONV 6W 350MA 230V 1-10	0.05	96107648
LED CONV 8W 350MA 100-240V 3PLUG	0.08	96107646
D-CO LED Downlight Drivers 700mA		
LED CONV 12W 700MA 100-240V 6PLUG	0.15	96108002
LED CONV 18W 700MA 100-240V 6PLUG	0.22	96108003
LED CONV 3W 700MA 100-240V 3PLUG	0.26	96108001
Accessories		
LED EXTENSION 1M SOCKET/CLIP 350MA	0.02	96108024
LED EXTENSION 1M SOCKET/CLIP 700MA	0.02	96108025
LED MULTIPLUG BRIDGE 350MA 25-PCS	0.002	96108128
LED MULTIPLUG BRIDGE 700MA 25-PCS	0.001	96108129
MULTIPLUG 3WAY SERIES 350MA LED	0.02	96107650
MULTIPLUG 3WAY SERIES 700MA LED	0.02	96107980
MULTIPLUG 6WAY SERIES 350MA LED	0.03	96107651
MULTIPLUG 6WAY SERIES 700MA LED	0.03	96108000
PLUG/SOCKET EXTENSION 2M 350MA LED	0.03	96107977
PLUG/SOCKET EXTENSION 2M 700MA LED	0.03	96107978

GRY - Grey, WHI - White

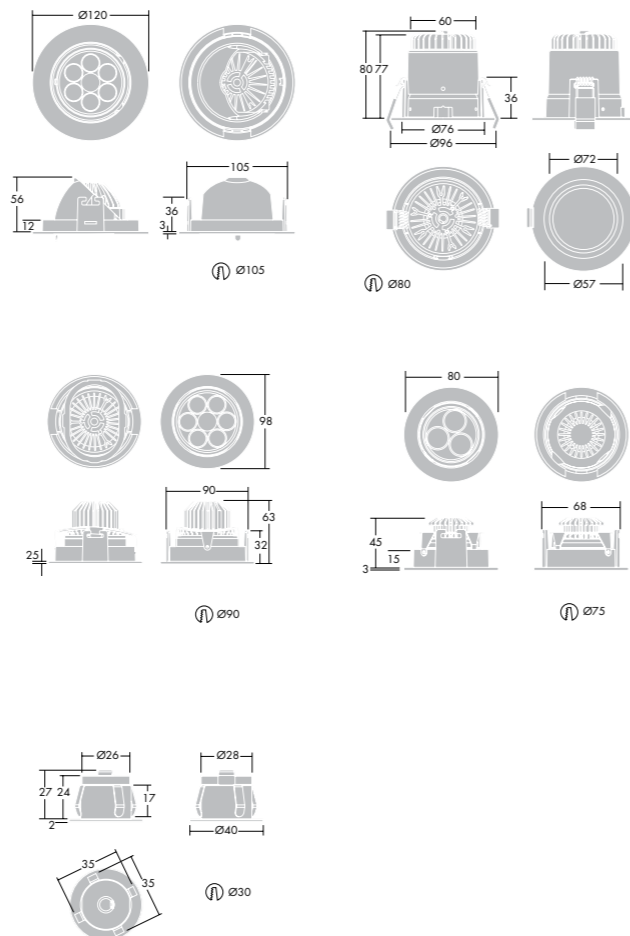

D-CO LED Recessed

Description	Wt (kg)	SAP Code
D-CO LED Recessed Mini		
D-CO R LED MINI 1X1,2W BLU CL	0.50	96257229
D-CO R LED MINI 1X1,2W BLU EW2	0.50	96257235
D-CO R LED MINI 1X1,2W BLU FR	0.50	96257232
D-CO R LED MINI 1X1,2W WHI 3K CL	0.50	96257228
D-CO R LED MINI 1X1,2W WHI 3K EW2	0.50	96257234
D-CO R LED MINI 1X1,2W WHI 3K FR	0.50	96257231
D-CO R LED MINI 1X1,2W WHI 4K CL	0.50	96257227
D-CO R LED MINI 1X1,2W WHI 4K EW2	0.50	96257233
D-CO R LED MINI 1X1,2W WHI 4K FR	0.50	96257230
D-CO LED Recessed Mini Kits		
D-CO R LED MINI 6/1X1,2W BLU CL KIT	1.30	96257250
D-CO R LED MINI 6/1X1,2W BLU EW2 KIT	1.30	96257256
D-CO R LED MINI 6/1X1,2W BLU FR KIT	1.30	96257253
D-CO R LED MINI 6/1X1,2W WHI 3K CL KIT	1.30	96257249
D-CO R LED MINI 6/1X1,2W WHI 3K EW2 KIT	1.30	96257255
D-CO R LED MINI 6/1X1,2W WHI 3K FR KIT	1.30	96257252
D-CO R LED MINI 6/1X1,2W WHI 4K CL KIT	1.30	96257248
D-CO R LED MINI 6/1X1,2W WHI 4K EW2 KIT	1.30	96257254
D-CO R LED MINI 6/1X1,2W WHI 4K FR KIT	1.30	96257251
D-CO LED Recessed Medium		
D-CO R LED MEDIUM 1X1,2W BLU FR	0.70	96257238
D-CO R LED MEDIUM 1X1,2W WHI 3K FR	0.70	96257237
D-CO R LED MEDIUM 1X1,2W WHI 4K FR	0.70	96257236
D-CO LED Recessed Maxi		
D-CO R LED MAXI 6X1,2W BLU CL	3.00	96257241
D-CO R LED MAXI 6X1,2W WHI 3K CL	3.00	96257240
D-CO R LED MAXI 6X1,2W WHI 4K CL	3.00	96257239
D-CO R MAXI 14W TC-TSE E27 OS/FACI CL	3.00	96257243
D-CO R MAXI 50W QPAR-CB 51 GZ10 OS CL	3.00	96257242
D-CO LED Connection boxes		
CON CABLE BOX 2 ENTRIES 1 EXIT IP67	0.30	96257258
CON CABLE BOX 2 ENTRIES 6 EXIT IP67	0.40	96257259

BLU - Blue, WHI - White, CL - Clear, FR - Frosted

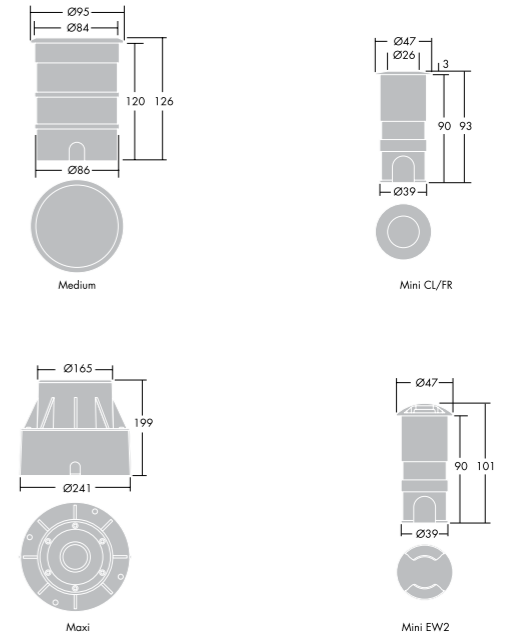

D-CO LED Spotlights

Description	Wt (kg)	SAP Code
D-CO LED Spotlights		
D-CO LED MINI FLEX 1X3W 3K 20° 230V GRY	0.18	96107867
D-CO LED MINI FLEX 1X3W 4K 20° 230V GRY	0.18	96107868
D-CO LED MINI SP 4/1X3W 3K20° 230V KIT	0.26	96107967
D-CO LED MINI SP 4/1X3W 4K20° 230V KIT	0.26	96107968
D-CO LED Spotlights without driver		
D-CO LED MINI FLEX 1X3W 3K 20° 700MA GRY	0.12	96107865
D-CO LED MINI FLEX 1X3W 4K 20° 700MA GRY	0.12	96107866
D-CO LED MINI SP 1X3W 3K 20° 700MA GRY	0.09	96107965
D-CO LED MINI SP 1X3W 4K 20° 700MA GRY	0.09	96107966
D-CO LED Drivers		
LED CONV 15/25W UNI 110-240V DIM	0.11	96107649
D-CO LED Accessories		
LED EXTENSION 1M SOCKET/CLIP 700MA	0.02	96108025
LED MULTIPLUG BRIDGE 700MA 25-PCS	0.001	96108129
MULTIPLUG 3WAY SERIES 700MA LED	0.02	96107980
MULTIPLUG 6WAY SERIES 700MA LED	0.03	96108000

GRY - Grey, SP - Spotlight

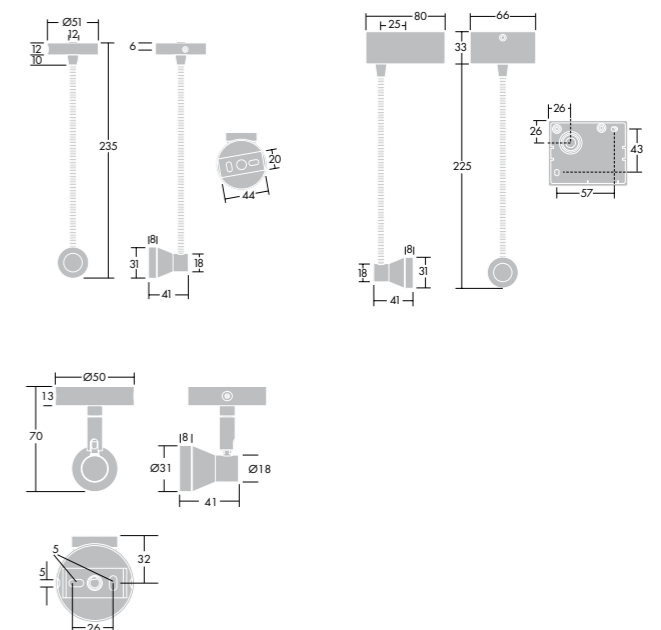

Ordering Guides and Line Drawings

D-CO LED Wall Recessed

Description	Wt (kg)	SAP Code
Wall recessed		
D-CO LED WALL ASYM 1,6W 3K 24V	0.10	96107419
D-CO LED WALL ASYM 1,6W 6.5K 24V	0.10	96107420
Accessories		
D-CO LED WALL CONCRETE MTG BOX	0.60	96107421
D-CO LED WALL CONCRETE MTG BOX DEEP	0.80	96107422
LED 0025 K210 24V ONE4ALL	0.15	86455937
LED CONV 10W 230V DC24V THO	0.05	96108127
LED CONV 12W 350MA 100-240V 6PLUG	0.14	96107647
LED CONV 15/25W UNI 110-240V DIM	0.11	96107649
LED CONV 25W DC24V	0.15	96107645
LED CONV 6W 350MA 230V 1-10	0.05	96107648
LED CONV 8W 350MA 100-240V 3PLUG	0.08	96107646
MULTIPLUG 3WAY SERIES 350MA LED	0.02	96107650
MULTIPLUG 6WAY SERIES 350MA LED	0.03	96107651

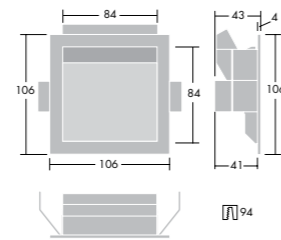

Prospector LED

Description	Wt (kg)	SAP Code
Prospector LED 3 circuit track mounted		
PROSPECTOR 1X12W LED L927 MT3 SP GRY	1.20	96107962
PROSPECTOR 1X12W LED L927 MT3 SP WHI	1.20	96107961
Prospector LED ceiling suspended		
PROSPECTOR 1X12W LED L927 PEND SP GRY	1.20	96107964
PROSPECTOR 1X12W LED L927 PEND SP WHI	1.20	96107963

WHI - White, GRY - Grey, MT3 - Track mounted, PEND - Pendant

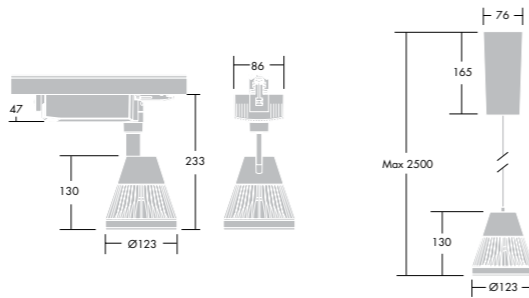

Tidon LED

Description	Wt (kg)	SAP Code
Tidon LED versions		
TIDON-S1 1X20W LED FL L830 GRY	1.50	96107408
TIDON-S1 1X20W LED FL L840 GRY	1.50	96107410
TIDON-S1 1X20W LED SP L830 GRY	1.50	96107407
TIDON-S1 1X20W LED SP L840 GRY	1.50	96107409
TIDON-S2 2X20W LED FL L830 GRY	2.80	96107412
TIDON-S2 2X20W LED FL L840 GRY	2.80	96107414
TIDON-S2 2X20W LED SP L830 GRY	2.80	96107411
TIDON-S2 2X20W LED SP L840 GRY	2.80	96107413
TIDON-S3 3X20W LED FL L830 GRY	4.00	96107416
TIDON-S3 3X20W LED FL L840 GRY	4.00	96107418
TIDON-S3 3X20W LED SP L830 GRY	4.00	96107415
TIDON-S3 3X20W LED SP L840 GRY	4.00	96107417
Tidon LED driver		
LED CONV 15/25W UNI 110-240V DIM	0.11	96107649
LED CONV 50W UNI DALI	0.15	96108026
Tidon Mixed equipment versions		
TIDON-M2 LED FL L830 QR111 G53 GRY	2.40	96108006
TIDON-M2 LED SP L830 HIT G8,5 FL GRY	2.60	96108004
TIDON-M2 LED SP L840 HIT G8,5 FL GRY	2.60	96108005
TIDON-M3 2/LED FL L830 QR111 G53 GRY	3.60	96108014
TIDON-M3 2/LED SP L830 HIR111 GX8,5 GRY	3.60	96108012
TIDON-M3 2/LED SP L830 HIT G8,5 FL GRY	3.70	96108010
TIDON-M3 2/LED SP L840 HIR111 GX8,5 GRY	3.60	96108013
TIDON-M3 2/LED SP L840 HIT G8,5 FL GRY	3.70	96108011
Tidon Accessories for all versions		
TIDON-S1 WEIGHT DISTRIBUTION PANEL	0.40	96107652
TIDON-S2/S3 WEIGHT DISTRIBUTION PANEL	0.80	96107653

SP - Spot beam, FL - Flood beam, GRY - Grey

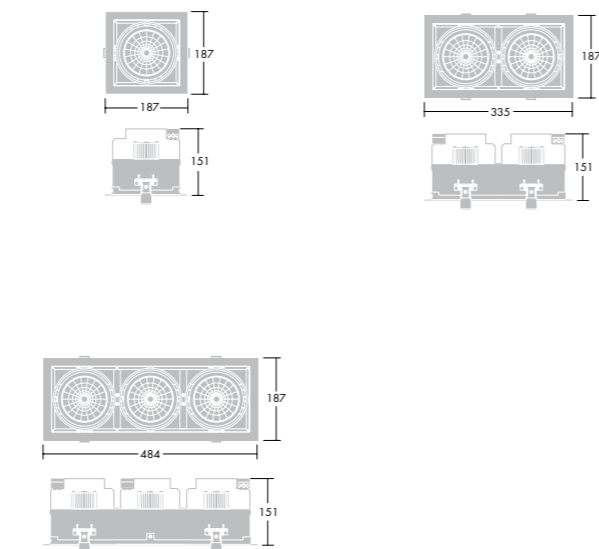

Glacier II LED

Description	Wt (kg)	SAP Code
Glacier II Small, prismatic reflector		
GLACIER II S LED 12W 2,7K 230V PRISM REFL	3.70	96207555
GLACIER II S LED 20W 3K 230V PRISM REFL	3.70	96207558
GLACIER II S LED 20W 4K 230V PRISM REFL	3.70	96207561
Glacier II Small, aluminium reflector		
GLACIER II S LED 12W 2,7K 230V ALU REFL	2.00	96207554
GLACIER II S LED 20W 3K 230V ALU REFL	2.00	96207557
GLACIER II S LED 20W 4K 230V ALU REFL	2.00	96207560
Glacier II Small, opal reflector		
GLACIER II S LED 12W 2,7K 230V OP REFL	3.20	96207553
GLACIER II S LED 20W 3K 230V OP REFL	3.20	96207556
GLACIER II S LED 20W 4K 230V OP REFL	3.20	96207559
Glacier II Accessories		
GLACIER II PROTECTIVE LAMP GLASS	0.75	96205380
GLACIER II PROTECTIVE PC COVER	0.10	96206178
GLACIER II S PROTECTIVE LAMP GLASS	0.30	96205381
THORN CEILING ROSE	0.50	96205307
THORN CEILING ROSE 1X26W TC-TEL HF E3TX	2.00	96205348
THORN CEILING ROSE 1X42W TC-TEL HF E3TX	2.00	96205349
THORN CEILING ROSE 1X57W TC-TEL HF E3	2.00	96205350
THORN CEILING ROSE EMERGENCY	2.00	96205308

OP - Opal, ALU - Aluminium, PRISM - Prismatic, REFL - Reflector, PC - Polycarbonate

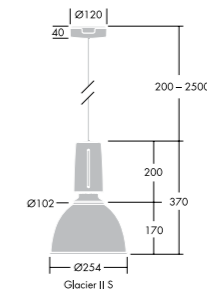

Voyager LED Series

Description	Wt (kg)	SAP Code
Area		
VOYAGER LED AREA KIT E3M	0.30	96503731
VOYAGER LED AREA KIT E3TX	0.30	96503732
VOYAGER LED AREA MCE E3M SIL	0.80	96503723
VOYAGER LED AREA MCE E3M WHI	0.80	96503725
VOYAGER LED AREA MCE E3TX SIL	0.80	96503724
VOYAGER LED AREA MCE E3TX WHI	0.80	96503726
VOYAGER LED AREA MRE E3M SIL	1.20	96503727
VOYAGER LED AREA MRE E3M WHI	1.20	96503729
VOYAGER LED AREA MRE E3TX SIL	1.20	96503728
VOYAGER LED AREA MRE E3TX WHI	1.20	96503730
Route		
VOYAGER LED ROUTE KIT E3M	0.30	96503721
VOYAGER LED ROUTE KIT E3TX	0.30	96503722
VOYAGER LED ROUTE MCE E3M SIL	0.80	96503713
VOYAGER LED ROUTE MCE E3M WHI	0.80	96503715
VOYAGER LED ROUTE MCE E3TX SIL	0.80	96503714
VOYAGER LED ROUTE MCE E3TX WHI	0.80	96503716
VOYAGER LED ROUTE MRE E3M SIL	1.20	96503717
VOYAGER LED ROUTE MRE E3M WHI	1.20	96503719
VOYAGER LED ROUTE MRE E3TX SIL	1.20	96503718
VOYAGER LED ROUTE MRE E3TX WHI	1.20	96503720
Spot		
VOYAGER LED SPOT KIT E3M	0.30	96236612
VOYAGER LED SPOT KIT E3TX	0.30	96236613
VOYAGER LED SPOT MCE E3M SIL	0.80	96236608
VOYAGER LED SPOT MCE E3M WHI	0.80	96236610
VOYAGER LED SPOT MCE E3TX SIL	0.80	96236609
VOYAGER LED SPOT MCE E3TX WHI	0.80	96236611
VOYAGER LED SPOT MRE E3M SIL	1.20	96503733
VOYAGER LED SPOT MRE E3M WHI	1.20	96503736
VOYAGER LED SPOT MRE E3TX SIL	1.20	96503734
VOYAGER LED SPOT MRE E3TX WHI	1.20	96503737
Accessory		
VOYAGER LED MCE BESA	0.15	96236796
VOYAGER LED RBOX PE MRE CONCRETE*	0.30	96236606

* Used in conjunction with recessed luminaires when mounting into concrete

E3M - 3 hour emergency manual test maintained, E3TX - 3 hour emergency SelfTest, or Addressable Test if connected to Explorer Project/Vision, KIT - for integration into luminaires, MCE - ceiling surface mounted, MRE - recessed mounted, PE - polyethylene, RBOX - recessing box, SIL - silver coloured, WHI - white

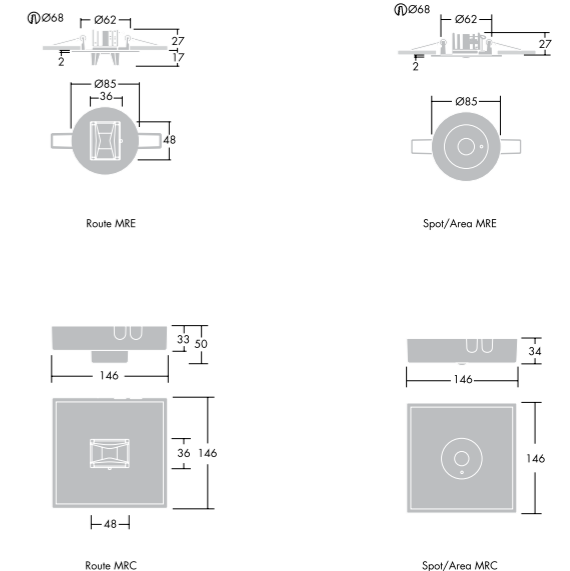

Ordering Guides and Line Drawings

Voyager LED

Description	Wt (kg)	SAP Code
Surface version		
VOYAGER LED E3M MCE LI	1.13	96102976
VOYAGER LED E3NM MCE LI	1.13	96102977
Suspended version		
VOYAGER LED E3M MSU LI	1.13	96102978
VOYAGER LED E3NM MSU LI	1.13	96102979
Legends		
VOYAGER LED LEG DOWN	0.33	96111010
VOYAGER LED LEG DOWN2	0.34	96111012
VOYAGER LED LEG LEFT	0.44	96111008
VOYAGER LED LEG LEFTRIGHT	0.33	96111011
VOYAGER LED LEG RIGHT	0.35	96111009

E3M - 3 hour emergency manual test maintained, E3TX - 3 hour emergency SelfTest, or Addressable Test if connected to Explorer Project/Vision, KIT - for integration into luminaires, MCE - ceiling surface mounted, MRE - recessed mounted, PE - polyethylene, RBOX - recessing box, SIL - silver coloured, WHI - white

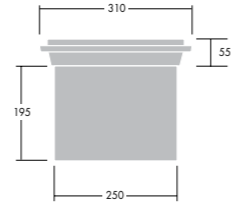

Voyager Sigma LED

Description	Wt (kg)	SAP Code
Voyager Sigma		
VOYAGER SIGMA LED E3M SIL	1.40	96233814
VOYAGER SIGMA LED E3M WHI	1.40	96233813
VOYAGER SIGMA LED E3TX SIL	1.40	96233816
VOYAGER SIGMA LED E3TX WHI	1.40	96233815
Legends		
VOYAGER SIGMA LEG EU DOWN	0.10	96233876
VOYAGER SIGMA LEG EU LEFT	0.10	96233877
VOYAGER SIGMA LEG EU RIGHT	0.10	96233878
VOYAGER SIGMA LEG EU UP	0.10	96233875
VOYAGER SIGMA LEG ISO DOWN	0.17	96236786
VOYAGER SIGMA LEG ISO LEFT	0.17	96236787
VOYAGER SIGMA LEG ISO RIGHT	0.10	96236788
VOYAGER SIGMA LEG ISO UP	0.17	96236785

E3M - 3 hour emergency manual test maintained, E3TX - 3 hour emergency SelfTest, or Addressable Test if connected to Explorer Project/Vision, SIL - silver, WHI - white
Both versions can be wired to operate as Non-maintained or Maintained.

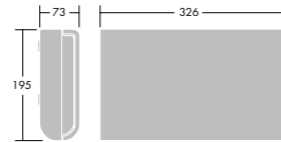

Netherburn Primary School, Scotland



Dollan Aqua Centre, Scotland



Tegvaerksbroen, Copenhagen



The Base of Guangzhou Tower, China

Thorn Lighting Main Offices

Thorn Academy of Light

Durhamgate, Spennymoor
County Durham DL16 6HL, UK
Tel: (44) 1388 420 042
E-mail: academy@thornlighting.com
Website: www.thornacademyoflight.com

Australia

Thorn Lighting Pty Limited
43 Newton Road, Wetherill Park
NSW 2164
Tel: (02) 8786 6000
Fax: (02) 9612 2700
E-mail: infoaustralia@thornlighting.com
Website: www.thornlighting.com.au

Austria

Thorn Licht GmbH
Donau-City-Straße 1,
1220 Wien, Austria
Tel: (43) 1 202 66 11
Fax: (43) 1 202 66 11 82712
E-mail: office.at@thornlighting.com
Website: www.thornlighting.at

Benelux

Rijksweg 47 A
Industriezone Puurs Nr. 442
BE-2870 Puurs, Belgium
Phone: +32 (0)3 860 16 60
Fax: +32 (0)3 860 16 69
e-mail: infobe@thornlighting.com
infonl@thornlighting.com
infolu@thornlighting.com

China

Thorn Lighting (Guangzhou) Limited
No. 12 Lianyun Road, Eastern Section, GETDO
Guangzhou 510530 P.R.China
Tel: (86) 20 3228 2706
Fax: (86) 20 3228 1777
E-mail: sales.cn@thornlighting.com

Thorn Lighting (Tianjin) Co. Ltd
332 Hongqi Road, Tianjin 300190, China
Tel: (86) 22 8369 2303
Fax: (86) 22 8369 2302
E-mail: info.tj@thornlighting.com

Croatia

Dravska 17
HR-42000 Varazdin
Tel: +385 42 290 471
+385 42 290 474
Fax: +385 42 290 470
E-mail: officehr@thornlighting.com
Website: www.thornlighting.com.hr

Czech Republic

Thorn Lighting CS spol. s r.o.,
Pekařská 621/7, 155 00 Praha 5
Czech Republic
Tel: (420) 224 315 252
Fax: (420) 233 326 313
E-mail: thorn.cz@thornlighting.com
Website: www.thornlighting.cz

Denmark

Thorn Lighting A/S
Kanonbådsvej 12B, Holmen,
1437 København K, Denmark
Tel: (45) 76 96 36 00
Fax: (45) 76 96 36 01
E-mail: info.dk@thornlighting.com
Website: www.thornlighting.dk

France

Thorn Europhane SA
156 Boulevard Haussmann,
Cedex 08, Paris 75379, France
Tel: (33) 1 49 53 6262
Fax: (33) 1 49 53 6240
Website: www.thornlighting.fr

Hong Kong

Thorn Lighting (Hong Kong) Limited
Unit 4301, Level 43, Tower 1,
Metroplaza, 223 Hing Fong Road,
Kwai Chung, N.T., Hong Kong
Tel: (852) 2578 4303
Fax: (852) 2887 0247
E-mail: info.hk@thornlighting.com

India

Thorn Lighting India Pvt. Ltd.
Unit No. 404, Western Edge-1
4th Floor, Located at CTS 163A/165
W.E Highway, Borivali (E)
Mumbai - 400 066, India
Board line: +91-22-40481900
Fax: +91-22-40481900
E-mail: international_sales@thornlighting.com
Website: www.thornlighting.in

International Sales

Thorn Europhane SA
156 Boulevard Haussmann
Cedex 08, Paris 75379, France
Tel: (33) 1 49 53 6262
Fax: (33) 1 49 53 6270
Email: international_sales@thornlighting.com
Website: www.thornlighting.com

Ireland

Thorn Lighting (Ireland) Limited
Century House
Harolds Cross Road
Dublin 6W
Tel: (353) 1 4922 877
Fax: (353) 1 4922 724
E-mail: dublinsales@thornlighting.com
Website: www.thornlighting.co.uk

Italy

Thorn Europhane Spa
Via G Di Vittorio, 2, Cadrano di Granarolo,
Bologna 40057, Italy
Tel: (39) 051 763391
Fax: (39) 051 763088
E-mail: info@thornlighting.it
Website: www.thornlighting.it

New Zealand

Thorn Lighting (NZ) Ltd
399 Rosebank Road, Avondale,
Auckland 1026
PO Box 71134, Rosebank,
Auckland 1348
Tel: (64) 9 828 7155
Fax: (64) 9 828 7591
E-mail: info.NZ@thornlighting.com
Website: www.thornlighting.co.nz

Norway

Thorn Lighting AS
Strømsveien 344, 1081 Oslo,
Norway
Tel: (47) 22 82 07 00
Fax: (47) 22 82 07 01
E-mail: info.no@thornlighting.com
Website: www.thornlighting.no

Poland

Thorn Lighting Polska Sp.z.o.o.,
Ul. Gazowa 26A, Wrocław 50-513,
Poland
Tel: (48) 71 7833 740
Fax: (48) 71 3366 029
E-mail: thorn.pl@thornlighting.com
Website: www.thornlighting.pl

Russia

Thorn Lighting
Novoslobodskaya Str., 21, office 406
Business Center "Novoslobodskaya 21",
Moscow 127030, Russia
Tel: (7) 495 981 35 41
Fax: (7) 495 981 35 42
E-mail: office.moscow@thornlighting.com
Website: www.thornlighting.ru

Singapore

Thorn Lighting (Singapore) Pte Ltd
5 Kaki Bukit Crescent, 04-02 Koyotech
Building, 416238 Singapore
Tel: (65) 6844 5800
Fax: (65) 6745 7707
E-mail: info.sg@thornlighting.com

Slovenia

Thorn Lighting
Dunajska cesta 159
Ljubljana, SI-1000
Tel: +386 31 388 965
Fax: +386 1 56 09 865
E-mail: office.si@thornlighting.com
Website: www.thornlighting.si

Sweden

Thorn Lighting AB
Industrigratan, Box 305, SE-261 23
Landskrona, Sweden
Tel: (46) 418 520 00
Fax: (46) 418 265 74
E-mail: info.se@thornlighting.com
Website: www.thornlighting.se

United Arab Emirates

Thorn Lighting Ltd Dubai
Al Shoala Building, Office 301,
Block E, Airport road, P.O. Box 1200,
Deira, Dubai, UAE
Tel: (971) 4 2940181
Fax: (971) 4 2948838
E-mail: marketing.mena@thornlighting.com
Website: www.thornlighting.com

United Kingdom

Thorn Lighting Ltd
Durhamgate, Spennymoor,
County Durham, DL16 6HL
Tel: +44 (0) 1388 42 00 42
Fax: +44 (0) 1388 42 01 56
Email: brochures.uk@thornlighting.com
Website: www.thornlighting.co.uk

www.thornlighting.com

Exclusive Distributor 

tel no: 02 8260 8023
mobile: 0919 088 4366
email: info@stealthventures.com.ph
web: www.stealthventures.com.ph

Thorn Lighting is constantly developing and improving its products. All descriptions, illustrations, drawings and specifications in this publication present only general particulars and shall not form part of any contract. The right is reserved to change specifications without prior notification or public announcement. All goods supplied by the company are supplied subject to the company's General Conditions of Sale, a copy of which is available on request. All measurements are in millimetres and weights in kilograms unless otherwise stated. Printed on Luxo Light.

Publication No: 543 (I5) Publication Date: 02/12